



530 EXC USA 2009



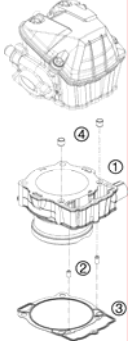

SPARE PARTS MANUAL: ENGINE

ART.NO.: 3CM089625IEN

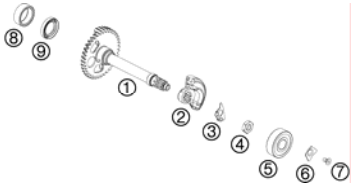
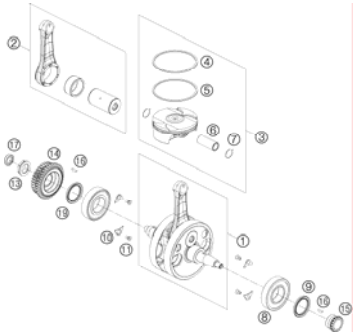
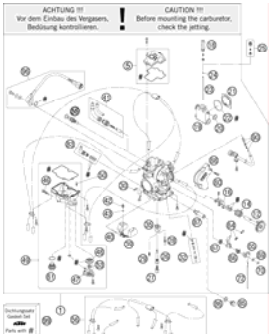
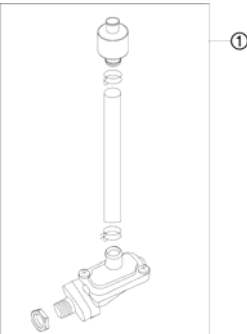
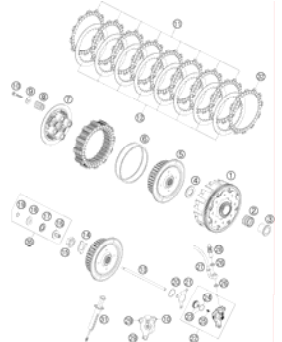
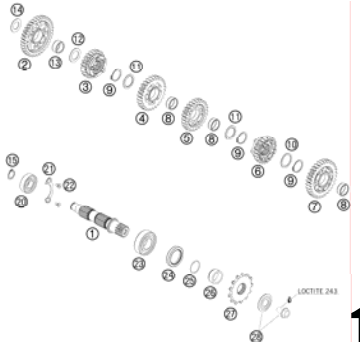
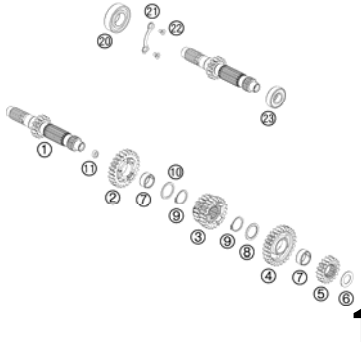
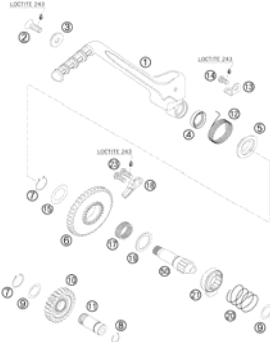
ENGLISH

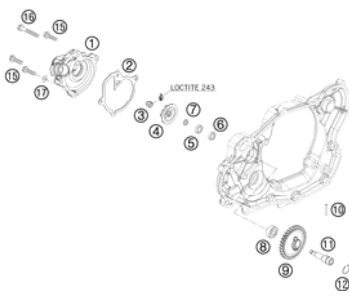
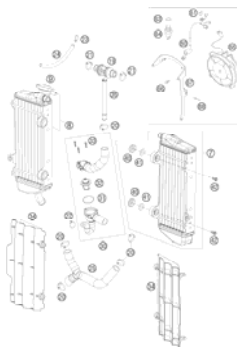

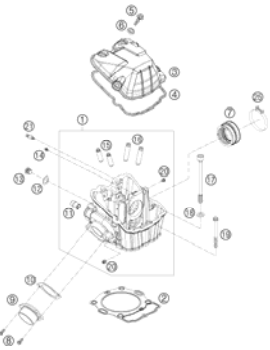
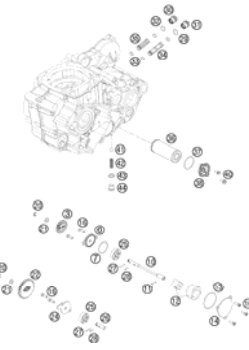
SPECIAL TOOLS  3	CYLINDER  4	ENGINE CASE  5	CLUTCH COVER  6
BALANCER SHAFT  7	CRANKSHAFT, PISTON  8	CARBURETOR  9	SECONDARY AIR SYSTEM SAS  12
CLUTCH  13	TRANSMISSION II - COUNTERSHAFT  14	TRANSMISSION I - MAIN SHAFT  15	KICK STARTER  16

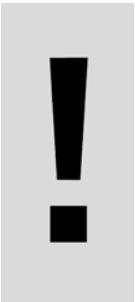
SHIFTING MECHANISM  17	WATER PUMP  18	COOLING SYSTEM  19	VALVE DRIVE  20
TIMING DRIVE  22	CYLINDER HEAD  23	LUBRICATING SYSTEM  24	IGNITION SYSTEM  25
ELECTRIC STARTER  26	 <p>All information contained is without obligation. KTM-Sportmotorcycle AG particularly reserves the right to modify any equipment, technical specifications, prices, colors, shapes, materials, services, service work, constructions, equipment and the like so as to adapt them to local conditions or to cancel any of the above items, all without previous announcement and without giving reasons. KTM may stop manufacturing certain models without previous notice. KTM shall not be held liable for any deviations of availability and/or ability to deliver, illustrations, descriptions, printing and/or other errors. The illustrated models partly contain extra equipment, which is not applied to standard models. © by KTM-SPORTMOTORCYCLE AG, Mattighofen AUSTRIA; All rights reserved; Reprint, also in extracts, with written allowance of KTM-SPORTMOTORCYCLE AG, Mattighofen only.</p>		

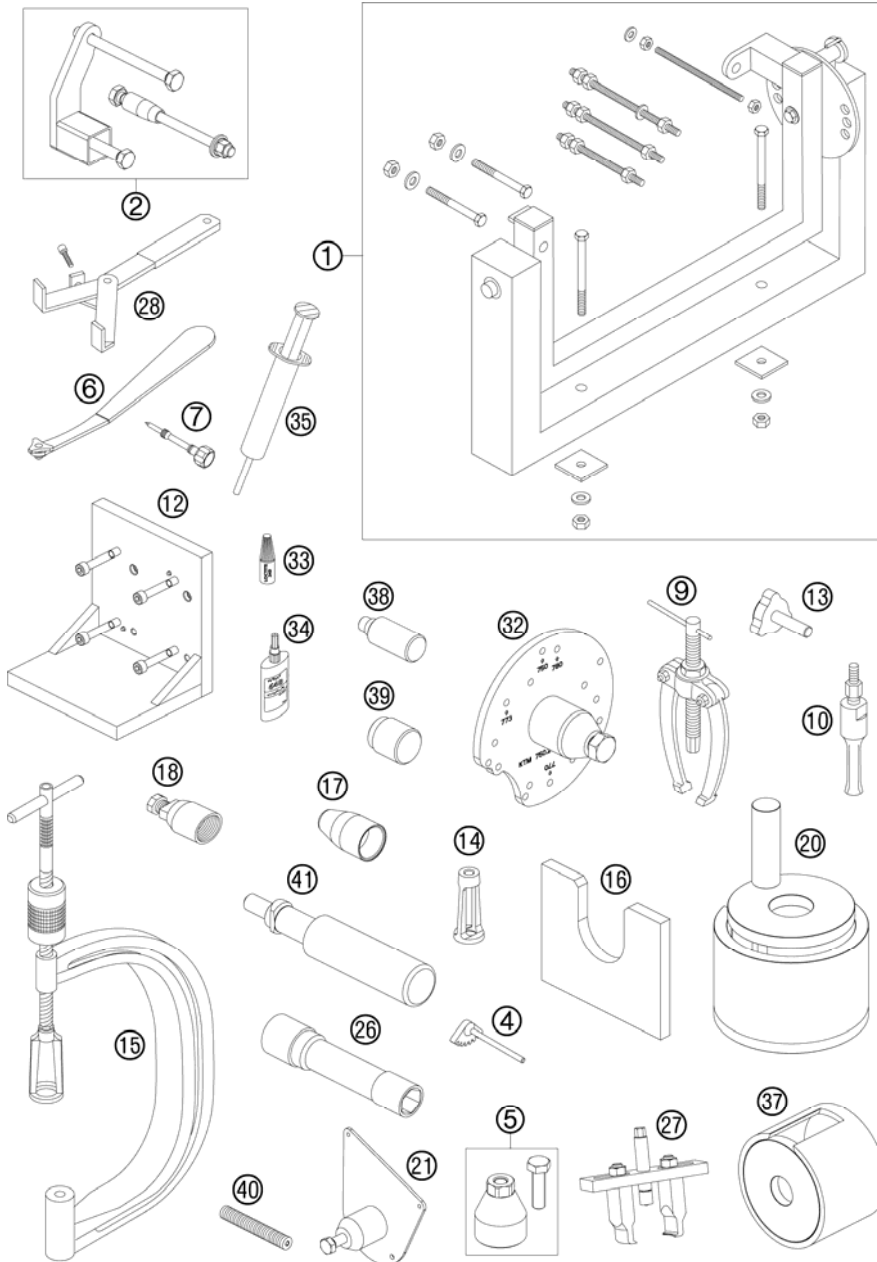

FIG	PART NUMBER	DESCRIPTION	QTY
1	56012001000	ASSY SUPPORT (WITHOUT HOLDER)	1
2	78029002000	SUPPORT CPL.	1
4	80029004000	GEAR SEGMENT CPL. 04	1
5	75029021000	EXTRACTOR PRIM. CPL.	1
6	77329034000	WRENCH F.MIXTURE CONTROL SCREW	1
7	59031017200	MIXT. CONTROL SCREW FACTORY 04	1
9	15112017000	BUSHING EXTRACTOR	1
10	15112018100	INTERN.BEAR.PULLER 18-23 MM	1
10	60029018000	INTERN.BEAR.PULLER 28 MM	1
12	75029050000	ON TENSIONER PL. CYLINDER HEAD	1
13	75029051000	PRESS OUT PUNCH CPL.	1
14	78029060000	VALVE SPRING TENSION APPLICAT.	1
15	59029019000	VALVE SPRING LEVER	1
16	78029009000	SEPARATOR PLATE CRANKSHAFT	1
17	78029005000	MOUNTING SLEEVE SSR CS	1
18	58012009000	FLYWHEEL EXTRACTOR	1
20	75029047000	PRESS. TOOL F. CRANKS. CPL.	1
21	78029049100	PRESS OUT PLATE CS CPL.	1
26	75029172000	SPARK PLUG WRENCH	1
27	78029033100	PULLER	1
28	51129003000	CLUTCH HOLDER	1
32	75029048000	CASING DISMOUNTING TOOL 07	1
33	6899785	LOCTITE 243 BLUE 6CCM	x
34	58429059000	LOCTITE 648 GREEN 24ML	x
35	58429059200	LOCTITE 5910 50ML	x
37	78029008000	PRESS. TOOL F. CRANKSHAFT	1
38	75029044020	PRESS PUNCH CAMSHAFT BEAR. SM.	1
39	75029044010	PRESS PUNCH CAMSH. BEAR. LARGE	1
40	0113080802	ENGINE BLOCKING SCREW	1
41	77329030100	PLUG IN FUSE PISTON PIN	1

097802910 / C097802910

* NEW PART

X AS REQUIRED

CYLINDER

530 EXC USA 2009

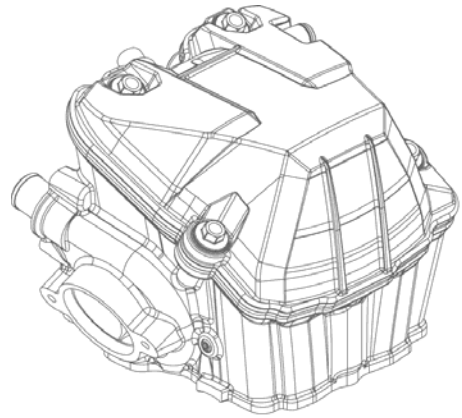

FIG	PART NUMBER	DESCRIPTION	QTY
1	78630005000	CYLINDER	1
2	59030023000	DOWEL 6X8X11,5	2
3	78030035000	CYLINDER BASE GASKET	1
4	58530014000	DOWEL 10,2X12,5X10 2001	2

087803040 / C087863040

* NEW PART

X AS REQUIRED

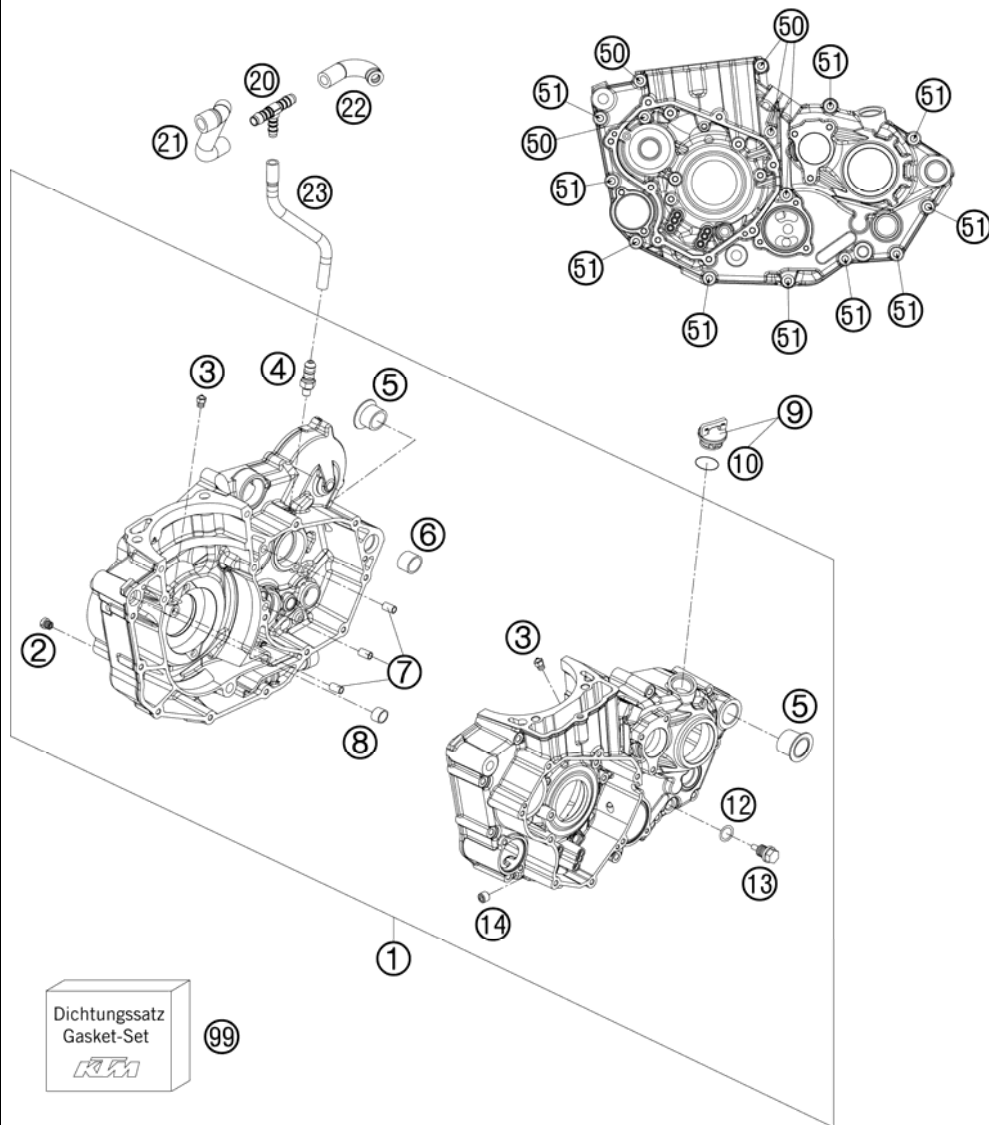

FIG	PART NUMBER	DESCRIPTION	QTY
1*	78030000144	ENGINE CASE CPL.W. BEARINGS 09	1
2*	57031523125	MAIN JET 125	1
3	60030063070	OIL JET 70 M5	2
4	58336020290	VACUUM CONNECTION M6X1 ALU AH	1
5	75030010000	CASE BUSH	2
6	54830027000	DOWEL 21X12 03	1
7	59030023000	DOWEL 6X8X11,5	3
8	51030026100	DOWEL 17 X 13 X 12	1
9	58030020100	PLUG CPL. M24X3	1
10	0770191015	O-RING 19,00X3,00 NBR	1
12	58038022000	CU-SEAL RING DIN7603-12X18X1,5	1
13	58030021000	OILDRAIN PLUG W.MAG. M 12X1,5	1
14	0906100100	PLUG DIN0906-M10X1	1
20	78030071000	T-PIECE 10/10/8MMM	1
21	78030087010	ENGINE BREATH HOSE EXC 08	1
22	78030087000	CARBURETOR BREATH HOSE EXC 08	1
23	78030087020	ENGINE CASE BREATH HOSE EXC 08	1
50	0025060756	HH COLLAR SCREW M6X75 TX30	5
51	0025060606	HH COLLAR SCREW M6X60 TX30	10
99	78030099000	GASKET SET 450/530 EXC 08	1

087803010 / C097803010

* NEW PART

X AS REQUIRED

CLUTCH COVER

530 EXC USA 2009

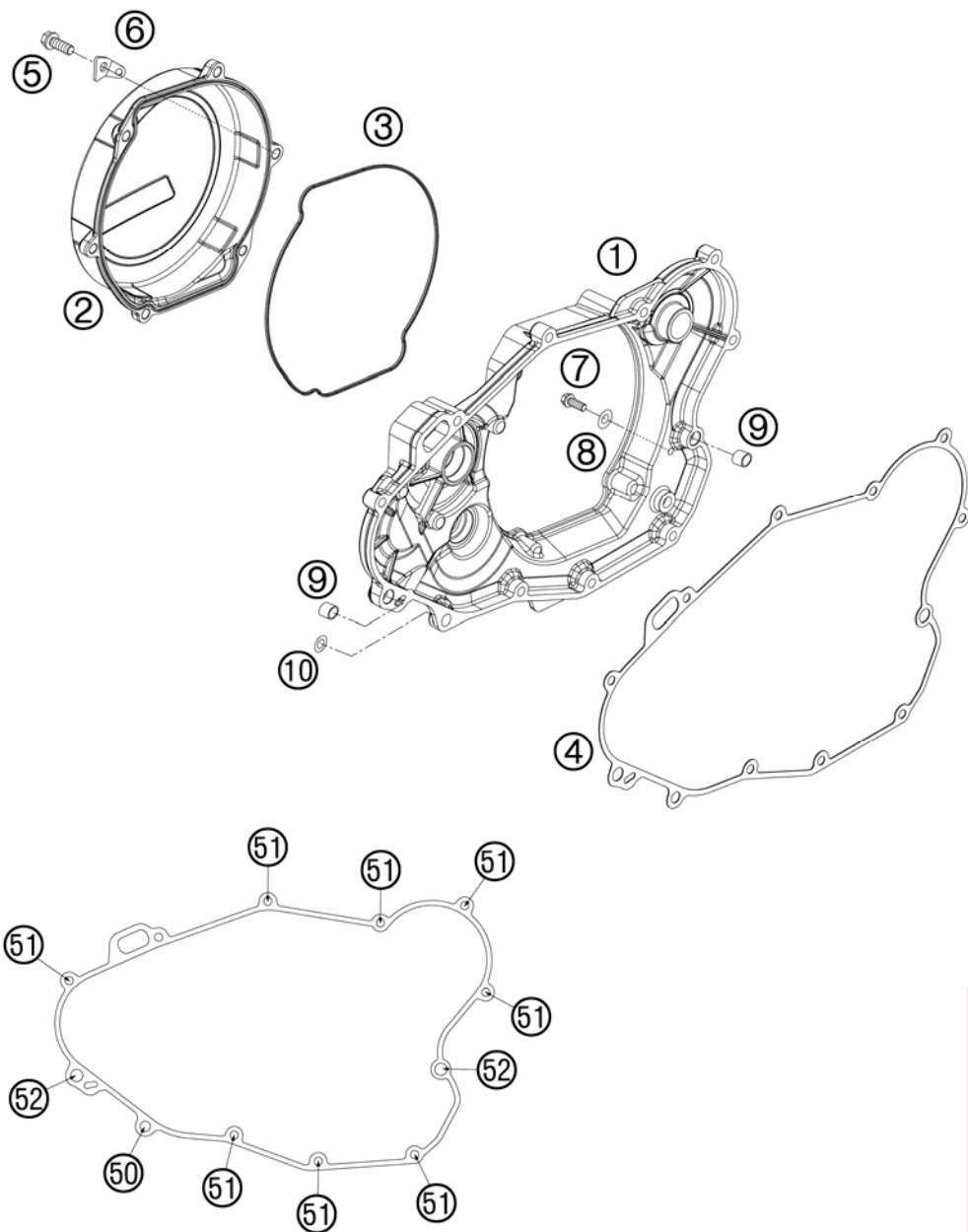

FIG	PART NUMBER	DESCRIPTION	QTY
1*	7803000104415	CLUTCH COVER GREY CPL. 09	1
2*	7803002610015	OUTER CLUTCH COVER	1
3	78030027000	GASKET OUTER CLUTCH COVER	1
4	78030025000	CLUTCH COVER GASKET 08	1
5	0025060206	HH COLLAR SCREW M6X20 TX30	6
6	78030028000	SPRING HANGER	1
7	0025060086	HH COLLAR SCREW M6X8 TX30	1
8	0603061001	CU-SEAL RING DIN7603-6X10X1	1
9	49030090000	DOWEL 9,8 X 7 X 10	2
10	58030081000	CU-SEAL RING 8 X 14 X 3	1
50	78030080000	LOCATING SCREW	1
51	0025060256	HH COLLAR SCREW M6X25 TX30	8
52	0025060306	HH COLLAR SCREW M6X30 TX30	2

087803020 / C097803020

* NEW PART

X AS REQUIRED

BALANCER SHAFT

530 EXC USA 2009

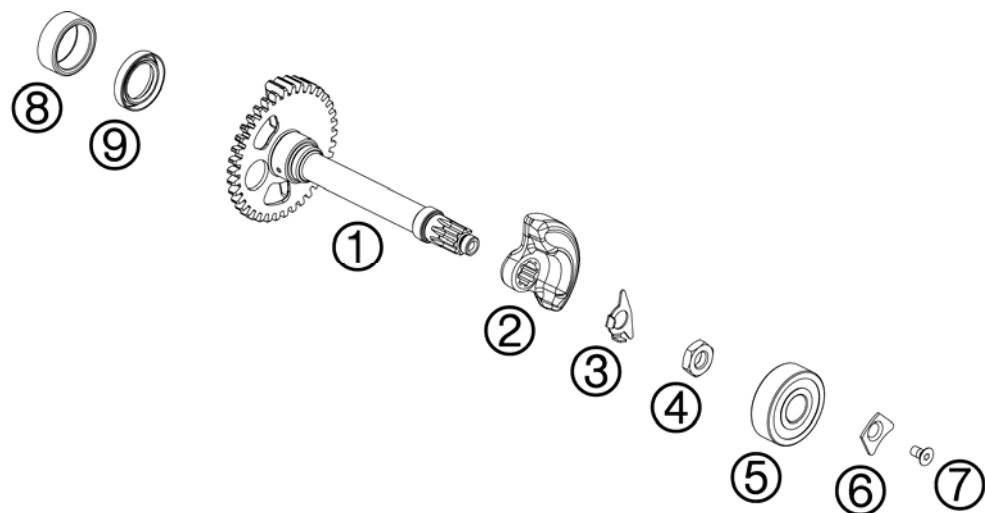

FIG	PART NUMBER	DESCRIPTION	QTY
1*	78030056100	BALANCE SHAFT	1
2	78030057000	BALANCE WEIGHT	1
3	78030068000	TAB WASHER	1
4	04391010031	HEXAGON NUT DIN0439-M10X1 A2	1
5	0625063020	BALL BEARING	1
6	78033232000	TAB WASHER	1
7	0019050103	INT. TORX FLAT HEAD M 5X10 8.8	1
8	0617253212	NEEDLE BEARING 25X32X12 HK2512	1
9*	0760203261	SHAFT SEAL RING 20X32X6 RUBBER	1

087803030 / C097803030

* NEW PART

X AS REQUIRED

CRANKSHAFT, PISTON

530 EXC USA 2009

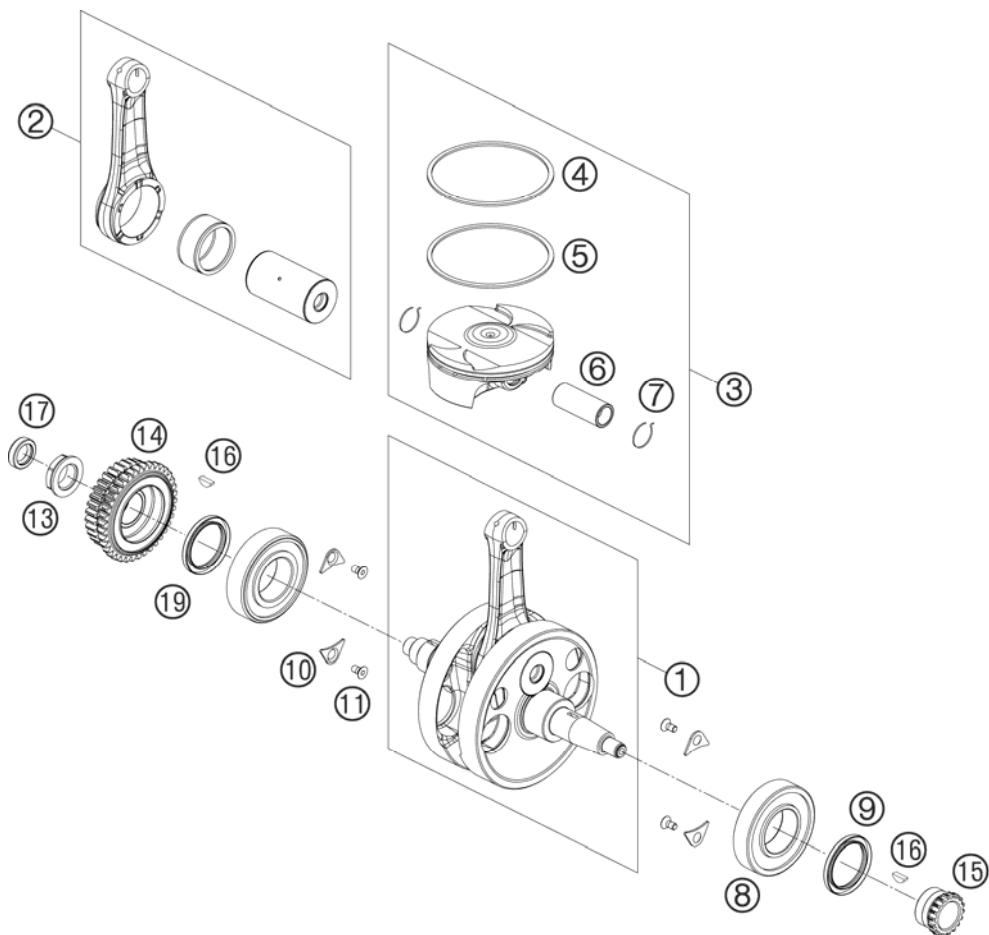

FIG	PART NUMBER	DESCRIPTION	QTY
1*	78630018300	CRANKSHAFT CPL.	1
2*	78630015144	CONNECT. ROD REPAIR SET 530 09	1
3	78630007200 I	PISTON CPL. D= 95 MM	1
3	78630007200 II	PISTON CPL. D= 95 MM	1
4	78030030000	COMPRESSION RING 08	1
5	78030032100	OIL SCRAPER RING	1
6	78030033000	PISTON PIN 08	1
7	77330074000	CIRCLIP	2
8	0625062071	BALL BEARING 6207 TM-SX07E 39	2
9*	0760354773	SHAFT SEAL RING 35X47X7 A-DUO	1
10	75030085000	RETAINING PLATE F. CS BEARING	4
11	0019050103	INT. TORX FLAT HEAD M 5X10 8.8	4
13*	78030029100	NUT PRIMARY WHEEL	1
14*	78032000233	PRIMARY WHEEL	1
15*	78036014200	TIMING GEAR 18T.	1
16	0888030037	WOODRUFF KEY DIN6888-3X3,7	2
17	0760142460	SHAFT SEAL RING 14X24X6 B	1
19*	0760354774	SHAFT SEAL RING 35X47X7 VITON	1

097803060 / C097863060

* NEW PART

X AS REQUIRED

CARBURETOR

530 EXC USA 2009

ACHTUNG !!!
Vor dem Einbau des Vergasers,
Bedüsung kontrollieren.

CAUTION !!!
Before mounting the carburetor,
check the jetting.

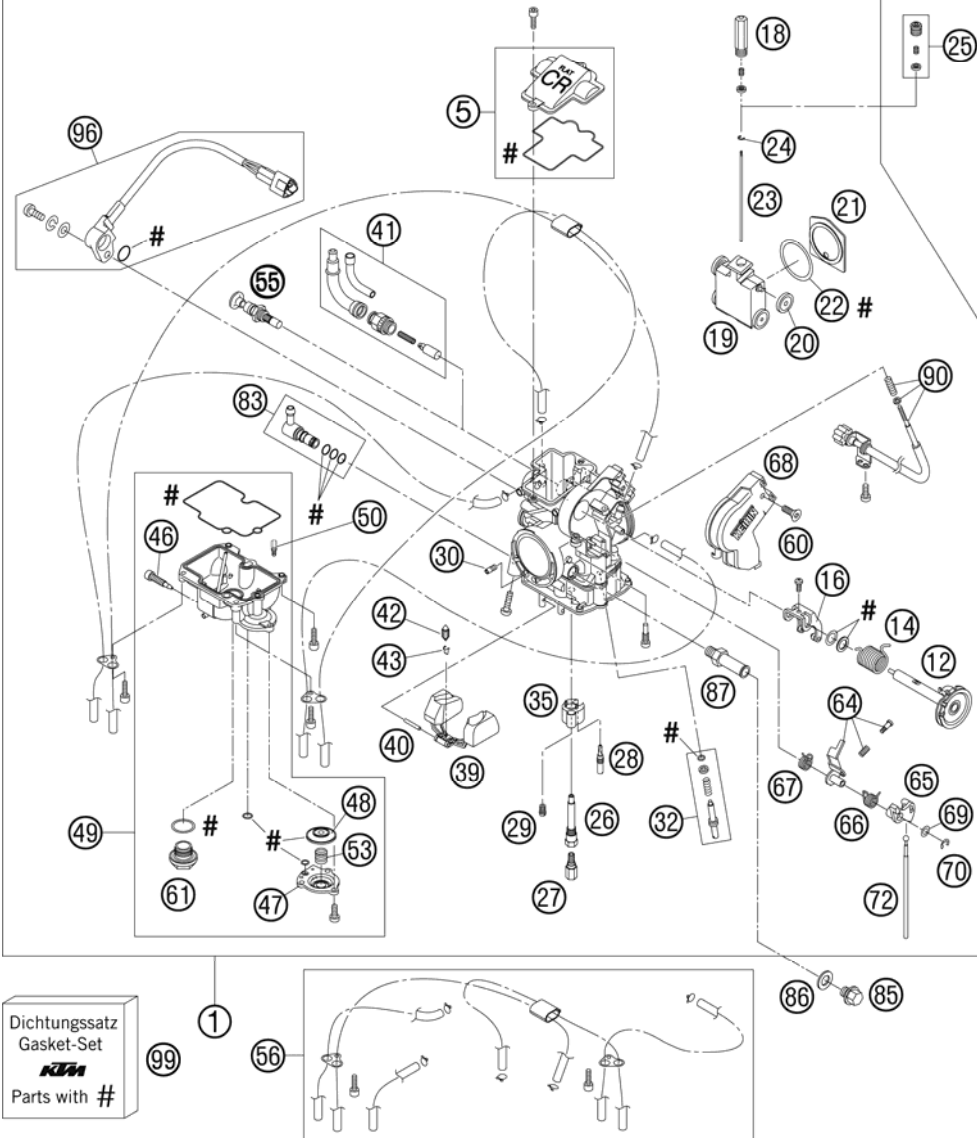

FIG	PART NUMBER	DESCRIPTION	QTY
1	78031001100	CARB. FCR-MX 3900L,TPS 08	1
5	57331027044	CARBURETOR COVER WITH GASKET	1
12	57331046100	THROTTLE SHAFT CPL. 06	1
14	57331046050	COIL SPRING THROTTLE SHAFT	1
16	76231035051	LINK ARM THROTTLE VALVE CPL.07	1
18	59031029010	SLIDE STOP 03	1
19	57331035100	THROTTLE VALVE CPL. FCRMX 2007	1
20	59031035050	BUSHING THROTTLE VALVE	1
21	57331035153	GASKET PLATE THROTTLE VALVE 04	1
22	59031035052	GASKET WASHER THROTTLE VALVE	1
23	59031034000	JET NEEDLE KEIHIN OBDTN	x
23	59031034400	JET NEEDLE KEIHIN OBDTP	x
23	59031034500	JET NEEDLE KEIHIN OBDTQ	x
23	59031034600	JET NEEDLE KEIHIN OBDTR	x
23	78031034000	JET NEEDLE KEIHIN OBDYU	x
23	78631034000	JET NEEDLE KEIHIN OBDZT	x
24	59031029000	BAR CLIP	1
25	57331032000	NEEDLE SET SCREW CPL.	1
26	59031121000	NEEDLE JET FCR-MX	1
27	54531623170	MAIN JET 170 KEIHIN	x
27	54531623172	MAIN JET 172 KEIHIN	x
27	54531623175	MAIN JET 175 KEIHIN	x
27	54531623178	MAIN JET 178 KEIHIN	x
27	54531623180	MAIN JET 180 KEIHIN	x
27	54531623182	MAIN JET 182 KEIHIN	x
27	54531623185	MAIN JET 185 KEIHIN	x
27	54531623188	MAIN JET 188 KEIHIN	x
28	54531607038	IDLE JET 38 KEIHIN	x
28	54531607040	IDLE JET 40 KEIHIN	x
28	54531607042	IDLE JET 42 KEIHIN	x
28	54531607048	IDLE JET 48 KEIHIN	x
29	59031051065	STARTER JET 65	x
29	59031051070	STARTER JET 70	x
29	59031051075	STARTER JET 75	x
29	59031051080	STARTER JET 80	x
29	59031051085	STARTER JET 85	x

087803110 / C087803110

* NEW PART

X AS REQUIRED

ACHTUNG !!!
Vor dem Einbau des Vergasers,
Bedüsung kontrollieren.

CAUTION !!!
Before mounting the carburetor,
check the jetting.

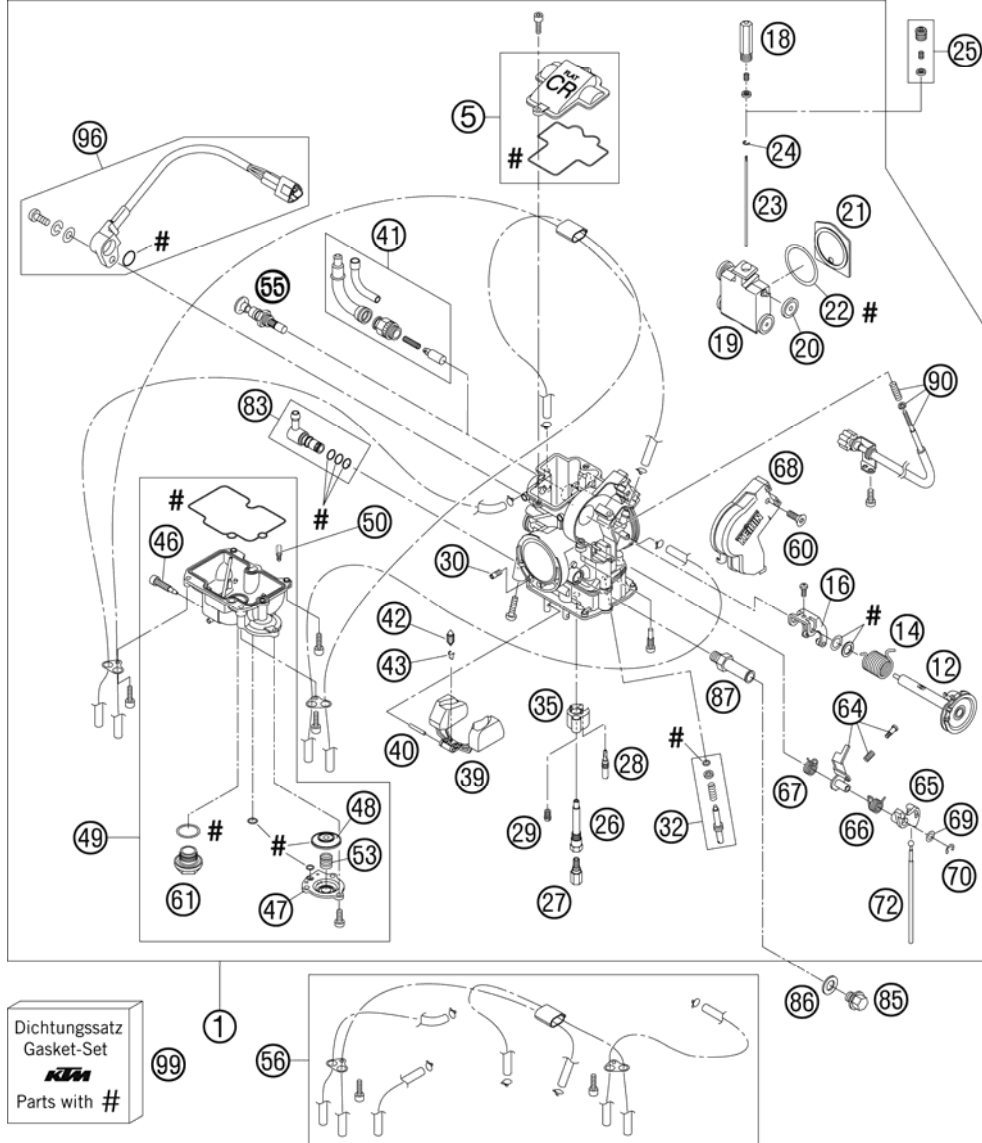

FIG	PART NUMBER	DESCRIPTION	QTY
30	57331107100	IDLE AIR JET 100 KEIHIN	1
32	59031017100	ADJUST SCREW CPL. FCR-MX	1
35	57331085000	BUFFER PLATE	1
39	57331009000	FLOAT CPL.	1
40	57331008000	ARM PIN FLOAT	1
41	78031096044	STARTER VALVE CPL.	1
42	54631220000	FLOAT NEEDLE	1
43	54531621000	CLAMP	1
46	76231155000	DRAIN SCREW FLOAT CHAMBER	1
47	57331060000	COVER ACCELERATOR PUMP	1
48	57331057100	DIAPHRAGM ACCELERATOR PUMP	1
49	78031011000	FLOAT CHAMBER CPL. 08	1
50	54631085000	JET POWER JET CLOSED KEIHIN	x
50	54631085040	JET POWER JET 40 KEIHIN	x
50	54631085050	JET POWER JET 50 KEIHIN	x
50	54631085060	JET POWER JET 60 KEIHIN	x
50	54631085070	JET POWER JET 70 KEIHIN	x
53	59031059000	COIL SPRING	1
55	77031048000	STARTER VALVE SHORT CPL.	1
56	57331098000	BREATH.HOSE FCR-MX KEIHIN CPL.	1
60	0965050103	FLAT HEAD SCREW DIN0965-M 5X10	1
61	54531699000	PLUG M 18X1	1
64	57331062000	INTERMEDIATE LEVER CPL.	1
65	57331056000	LINK LEVER	1
66	57331059000	SPRING LINK LEVER	1
67	57331159000	SPRING INTERMEDIATE LEVER	1
68	57331038200	CARBURETOR COVER 06	1
69	57331087000	WASHER LINK LEVER	1
70	57331084000	E-CLIP	1
72	57331061000	ROD ACCELERATOR PUMP	1
83	59031013044	HOSE CONNECTOR CPL.	1
85	0910100003	PLUG DIN0910-M 10X1	1
86	0603100141	COPPER GASKET DIN7603-10X14X1	1
87	59031040300	HOSE CONNECTOR KEIHIN	1
90	57331025000	STOP SCREW CPL. FCR-MX	1
96	59031077200	TPS-SENSOR FCRMX 190MM 2006	1

087803110 / C087803110

* NEW PART

X AS REQUIRED

CARBURETOR

530 EXC USA 2009

ACHTUNG !!!
Vor dem Einbau des Vergasers,
Bedüsung kontrollieren.



CAUTION !!!
Before mounting the carburetor,
check the jetting.

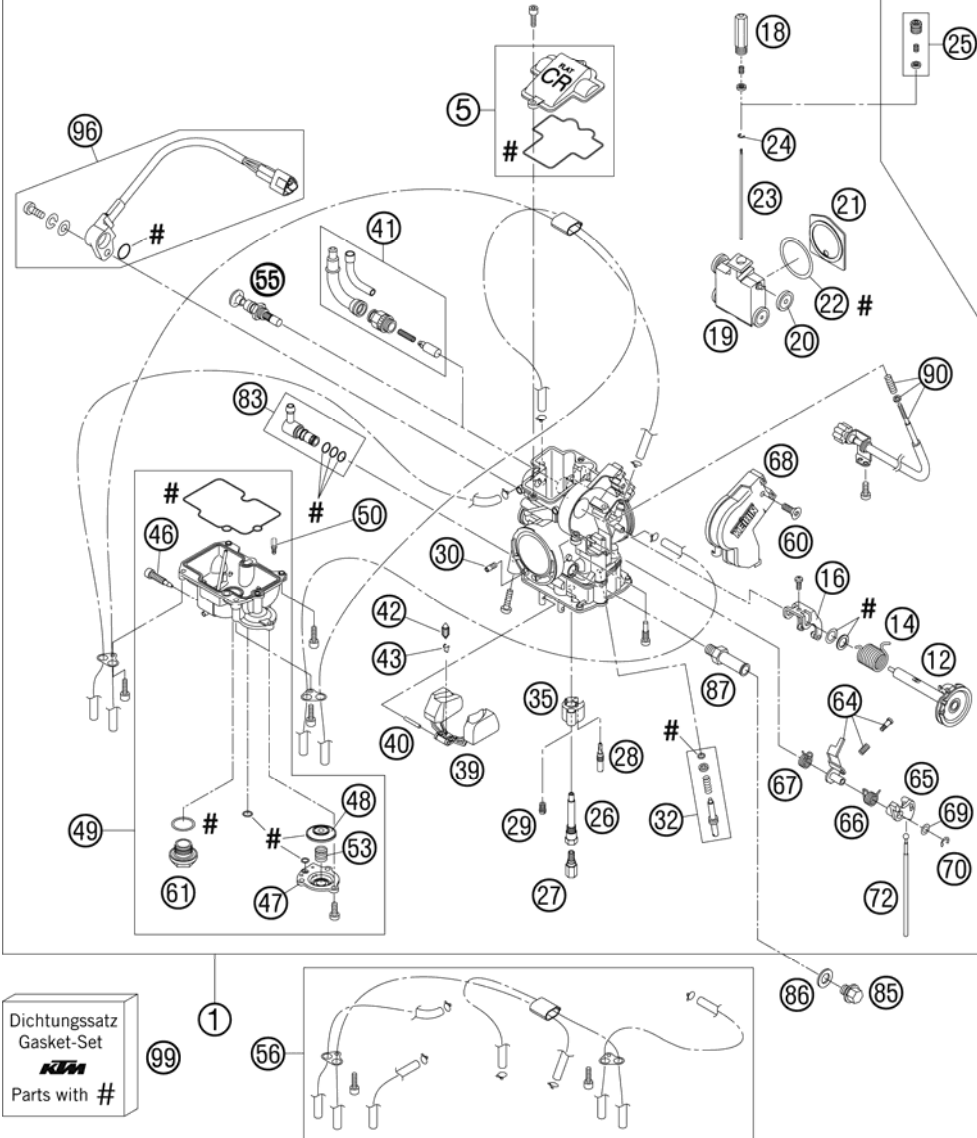

FIG	PART NUMBER	DESCRIPTION	QTY
99	57331099000	GASKET SET FCR-MX KEIHIN	1

087803110 / C087803110

* NEW PART

X AS REQUIRED

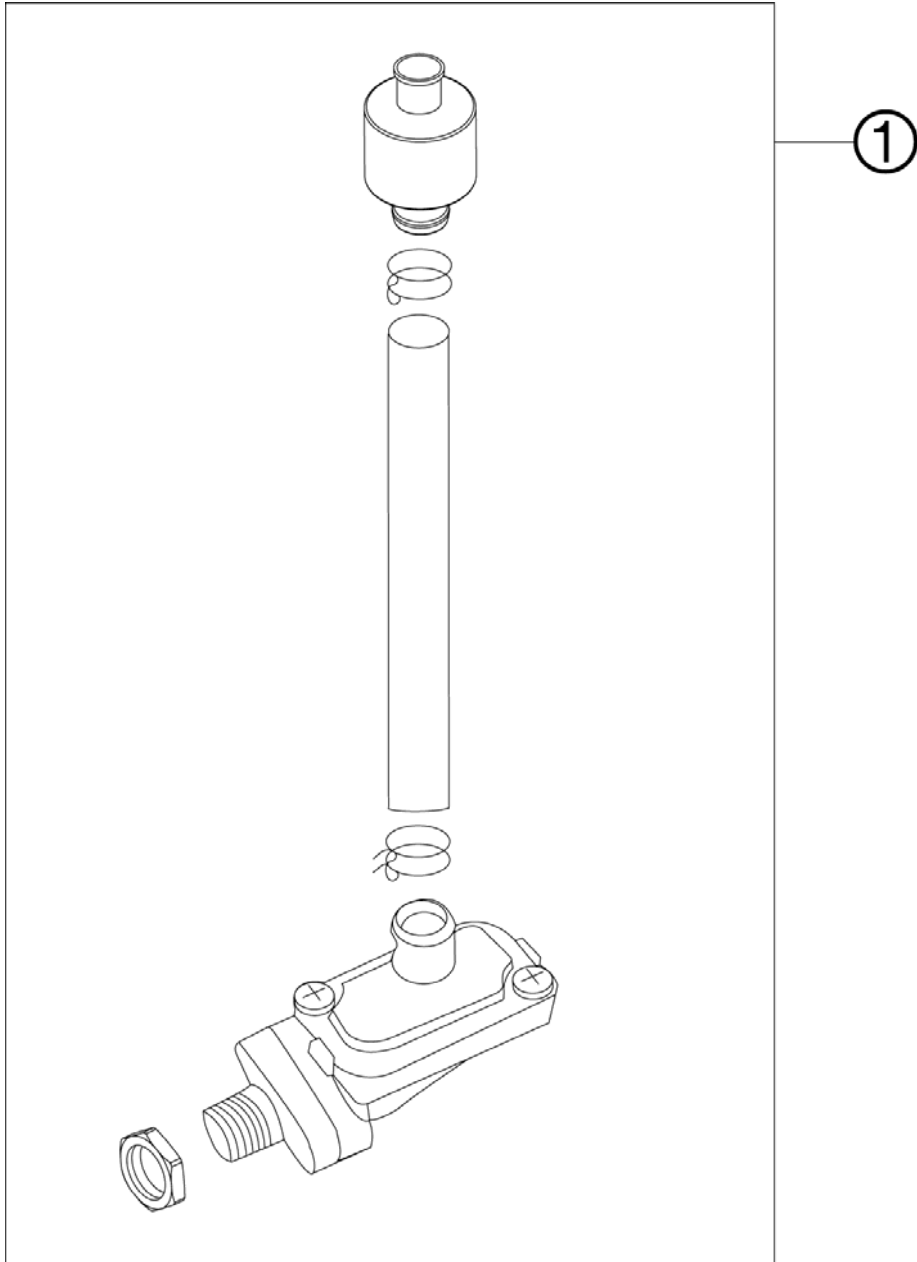

FIG	PART NUMBER	DESCRIPTION	QTY
1	78005024044	SAS-VALVE CPL. ONLY FOR EU	1

087803130 / C087803130

* NEW PART

X AS REQUIRED

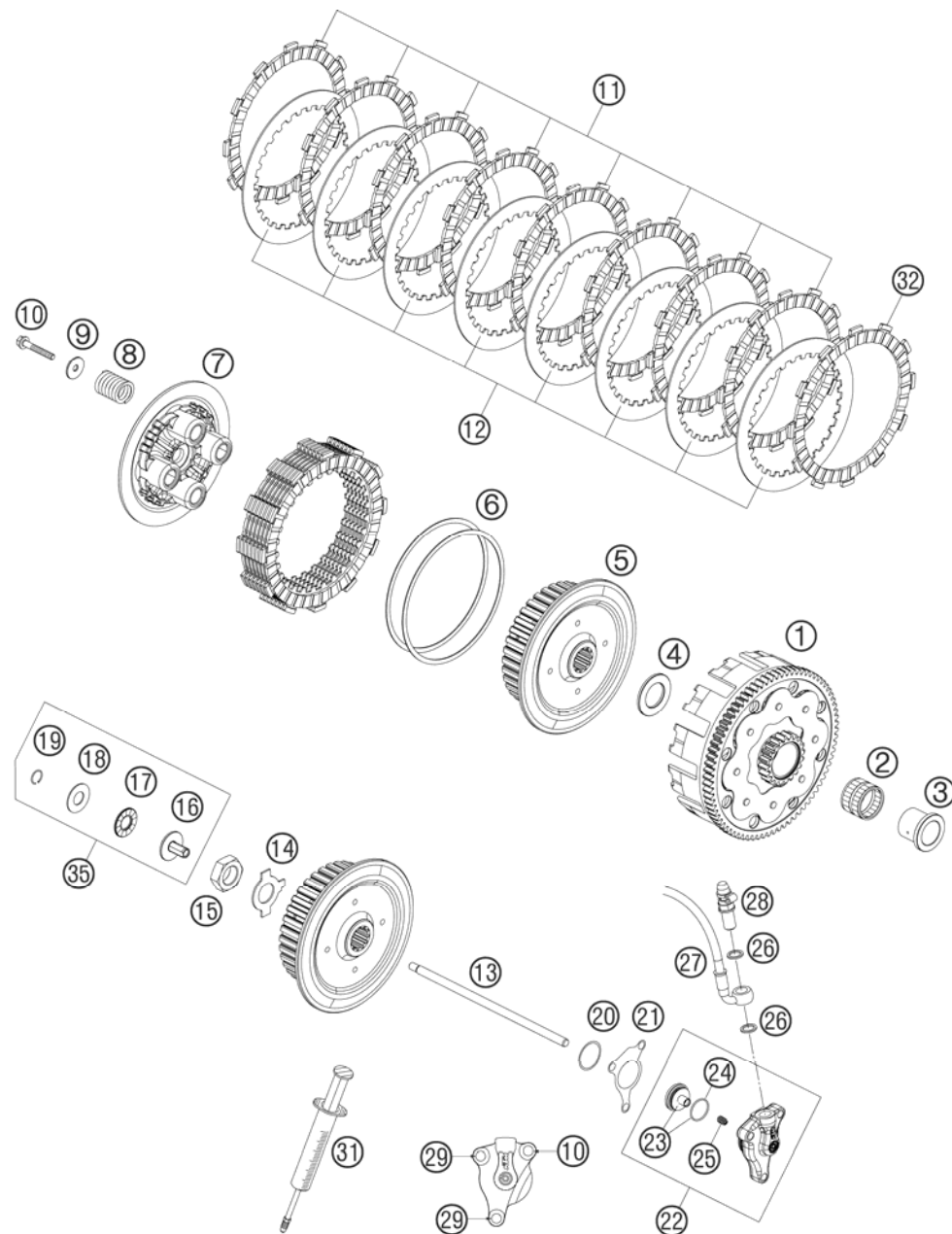

FIG	PART NUMBER	DESCRIPTION	QTY
1	78032001000	OUTER CLUTCH CPL. 08	1
2	56532095000	NEEDLE BEARING K26X30X22ZW.KSE	1
3	78032015000	INNER RING	1
4	78032020000	STOP DISC 08	1
5*	78032002200	INNER CLUTCH HUB	1
6	78032009000	JUDDER SPRING CPL.	1
7*	78032003100	PRESSURE PLATE	1
8	78032005000	CLUTCH SPRING 08	4
9*	58432081000	WASHER 6,5 X 20 X 2	4
10	0025060306	HH COLLAR SCREW M6X30 TX30	4
11	78032011000	LINING DISC 08	8
12*	78032010100	FRICTION PLATE STEEL	8
13*	78032054100	PUSH ROD L=186	1
14	77332018000	RETAINING PLATE	1
15	0936181505	HEXAGON NUT DIN0936-M18X1,5 R.	1
16*	78032057000	PRESSURE PIECE	1
17	54637097200	AXIAL NEEDLE BEARING AXK 1226	1
18	54637098200	AXIAL WASHER AS1226 12X26X1	1
19	0993012000	CIRCLIP DIN7993-RW12	1
20	0770300015	O-RING 30,00X1,50 NBR 70	1
21	59032065000	GASKET FOR SLAVE CYLINDER	1
22	54832061044	OUTPUT CYLINDER CPL. 06	1
23	54832066000	PISTON CPL.	1
24	54832067000	O-RING	1
25	54832069000	PRESSURE SPRING	1
26	0603100141	COPPER GASKET DIN7603-10X14X1	2
27	54832063000	CLUTCH PIPE 06	1
28	62513020000	BLEEDER SCREW CPL. 05	1
29	0025060206	HH COLLAR SCREW M6X20 TX30	2
31	50329050000	VENT INJEKTION HYDR. CLUTCH	1
32*	78032011100	FRICTION DISC	1
35*	78032057044	PRESSURE PIECE CPL. 08	1

097803210 / C097803210

* NEW PART

X AS REQUIRED

TRANSMISSION II - COUNTERSHAFT

530 EXC USA 2009

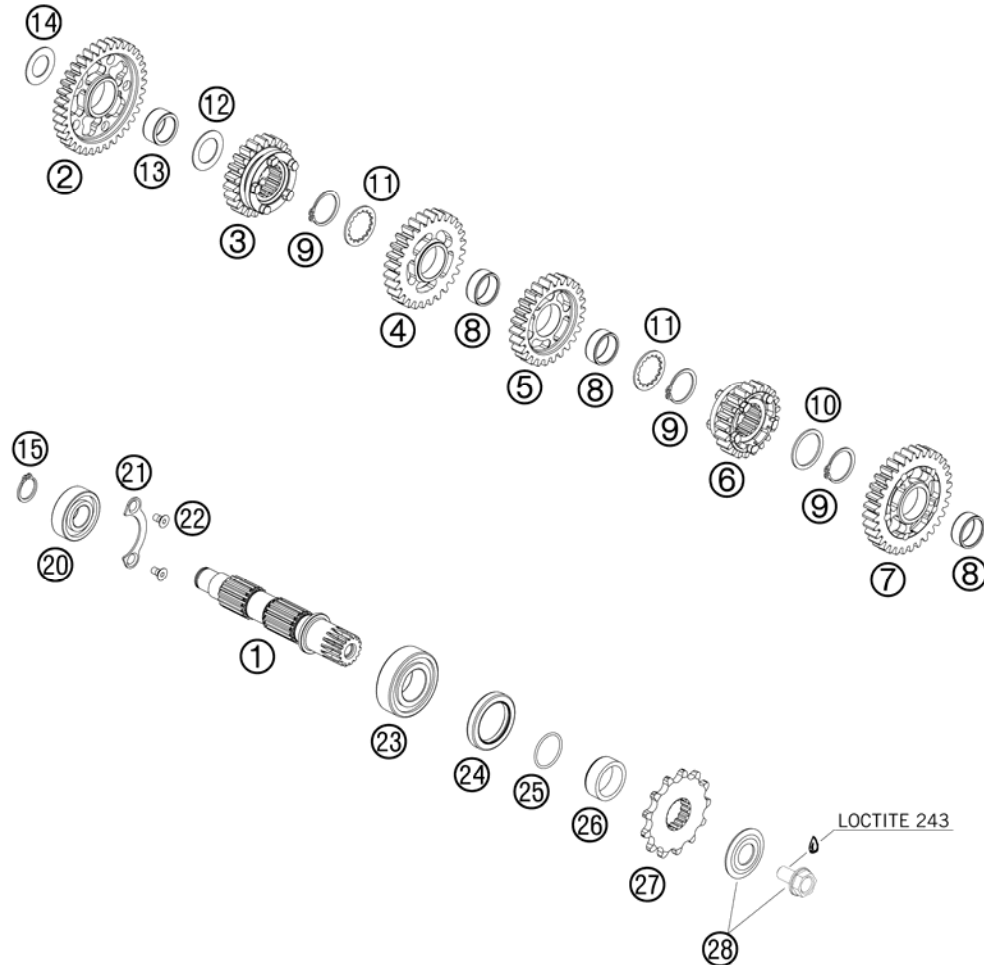

FIG	PART NUMBER	DESCRIPTION	QTY
1	78033010000	COUNTERSHAFT	08
2	78033011000	IDLER GEAR 1.G.	08
3	78033015000	SLIDING GEAR 5.G.	08
4	78033013000	IDLER GEAR 3.G.	08
5	78033014000	IDLER GEAR 4.G.	08
6	78033016000	SLIDING GEAR 6.G.	08
7	78033012000	IDLER GEAR 2.G.	08
8	0405222611	NEEDLE BEAR.K 22X26X10 DIVIDED	3
9	0471250120	CIRCLIP DIN0471-25X1,2	3
10	78033031000	STOP DISK 26 X 32 X 1,5	1
11	78033033000	STOP DISK 23 X 32 X 1,5	2
12	59033080000	SHIM 20X32X1	1
13	0405202612	NEEDLE BEARING K 20X26X12	1
14	56033030000	STOP DISC 17,2X30X1	1
15	0471170015	CIRCLIP DIN 0471-17X1, 5	1
20	0625062035	BALL BEARING 6203 JR2 C3	1
21	78033132000	TAB WASHER BEARING COUNT.SHAFT	1
22	0019050103	INT. TORX FLAT HEAD M 5X10 8.8	2
23	49030023000	CYL.ROLL BEARING NJ205	1
24	0760324571	SHAFT SEAL RING 32X45X7 BSLNBR	1
25	0770020220	O-RING 25,12X1,78 NBR70	1
26	54633014100	SPACER BUSHING 12MM	1
27	50033029013	SPROCKET 13-T	x
27	50033029014	SPROCKET 14-T	x
27	50033029015	SPROCKET 15-T	x
28	59033034044	SCREW+SPRING WASHER	1

087803360 / C087803360

* NEW PART

X AS REQUIRED

TRANSMISSION I - MAIN SHAFT

530 EXC USA 2009

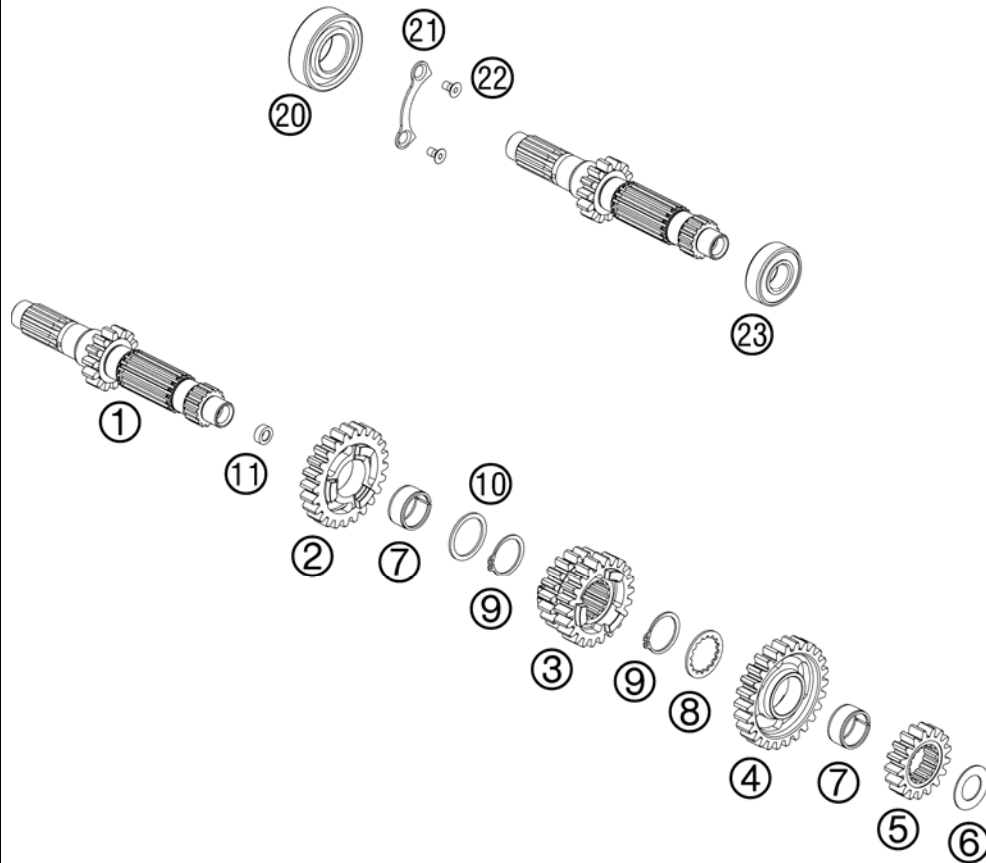

FIG	PART NUMBER	DESCRIPTION	QTY
1	78033001050	MAIN SHAFT 14 T	1
2	78033005000	IDLER GEAR 5.G.	1
3	78033003000	SLIDING GEAR 3/4 G.	08
4	78033006000	IDLER GEAR 6.G.	08
5	78033002000	SOLID GEAR 2.G.	08
6	56033030000	STOP DISC 17,2X30X1	1
7	0405222613	NEEDLE BEAR. K 22X26X13 TN	2
8	78033033000	STOP DISK 23 X 32 X 1,5	1
9	0471250120	CIRCLIP DIN0471-25X1,2	2
10	78033031000	STOP DISK 26 X 32 X 1,5	1
11*	78033001110	BUSHING	1
20	0625062054	BALL BEARING 6205 C3 NTN	1
21	78033032000	TAB WASHER BEARING MAIN SHAFT	1
22	0019050103	INT. TORX FLAT HEAD M 5X10 8.8	2
23	0625062036	BALL BEARING 6203 RSH C3	1

087803330 / C097803330

* NEW PART

X AS REQUIRED

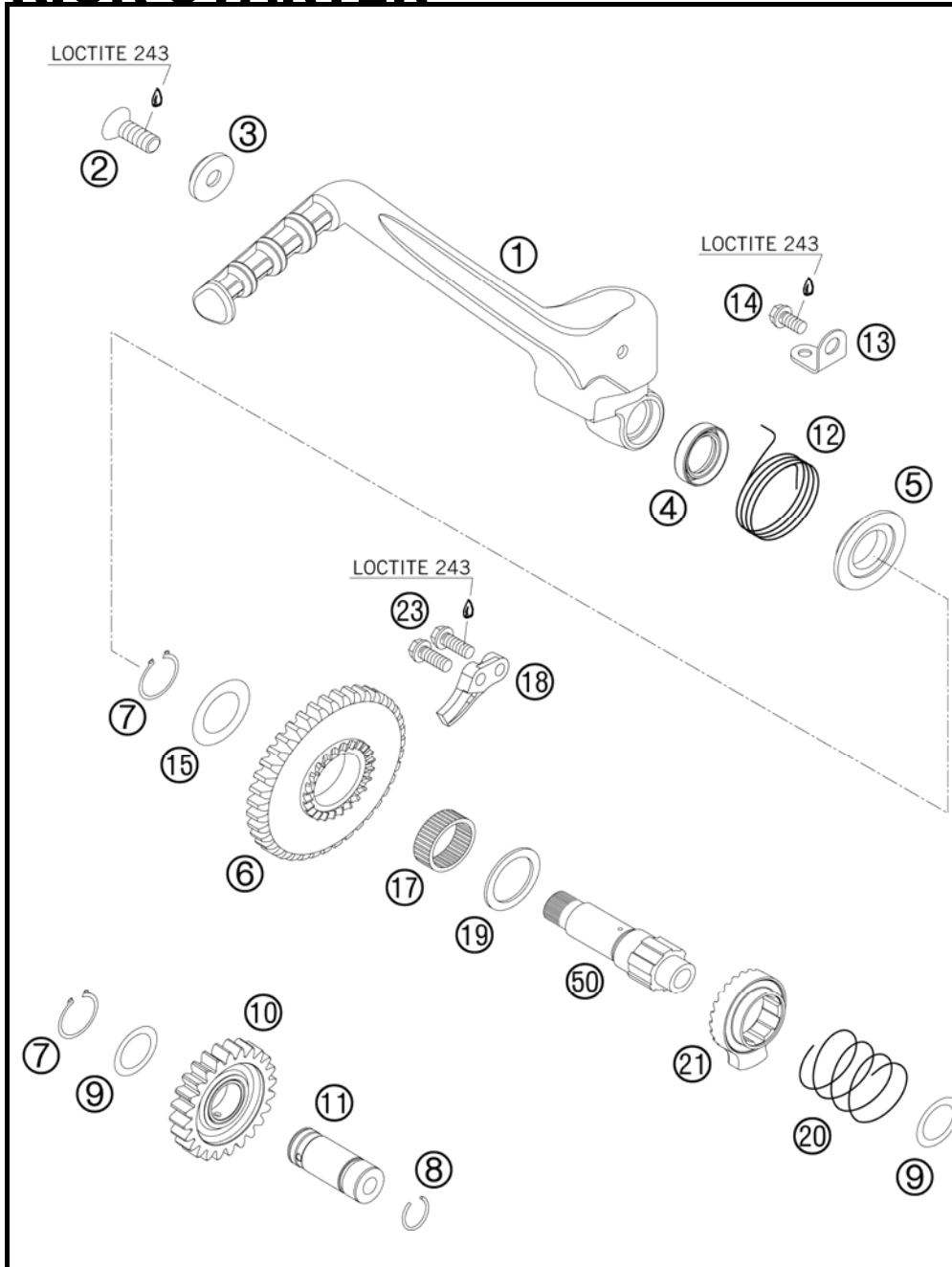

FIG	PART NUMBER	DESCRIPTION	QTY
1	77033170044	KICK STARTER CPL.	1
2	0019080206S	FLAT HEAD SCREW M. ISA45 M8X20	1
3	54633037000	WASHER 8MM GALVANIZED	1
4	0760193070	SHAFT SEAL RING 19X30X7 B	1
5	59033055000	DRIVING HUB	1
6	59033051039	KICKSTARTER GEAR 39-T	1
7	0471190120	CIRCLIP DIN0471-19X1,2	2
8	83033090000	CIRCLIP RB18	1
9	0988172405	SHIM WASHER DIN0988-17X24X0,5	2
10	78033053100	INTERMEDIATE GEAR CPL.	1
11	78033018100	BUSHING PIN	1
12	59033054000	KICKSTARTER SPRING	1
13	78033074000	SPRINGHOLDER 08	1
14	0912060123	AH SCREW DIN0912-M 6X12	1
15	59033080000	SHIM 20X32X1	1
17	0405222610	NEEDLE BEARING K 22X26X10 A	1
18	59033069000	BUMP PART	1
19	58033031000	STOP DISK 22,2 X 30 X 1,5	1
20	58033028000	RATCHET GEAR SPRING 1,2 MM	1
21	78033052000	RATCHET GEAR KICK STARTER	1
23	0025060206	HH COLLAR SCREW M6X20 TX30	2
50*	59033050100	KICKSTARTER SHAFT	1

087803390 / C097803390

* NEW PART

X AS REQUIRED

SHIFTING MECHANISM

530 EXC USA 2009

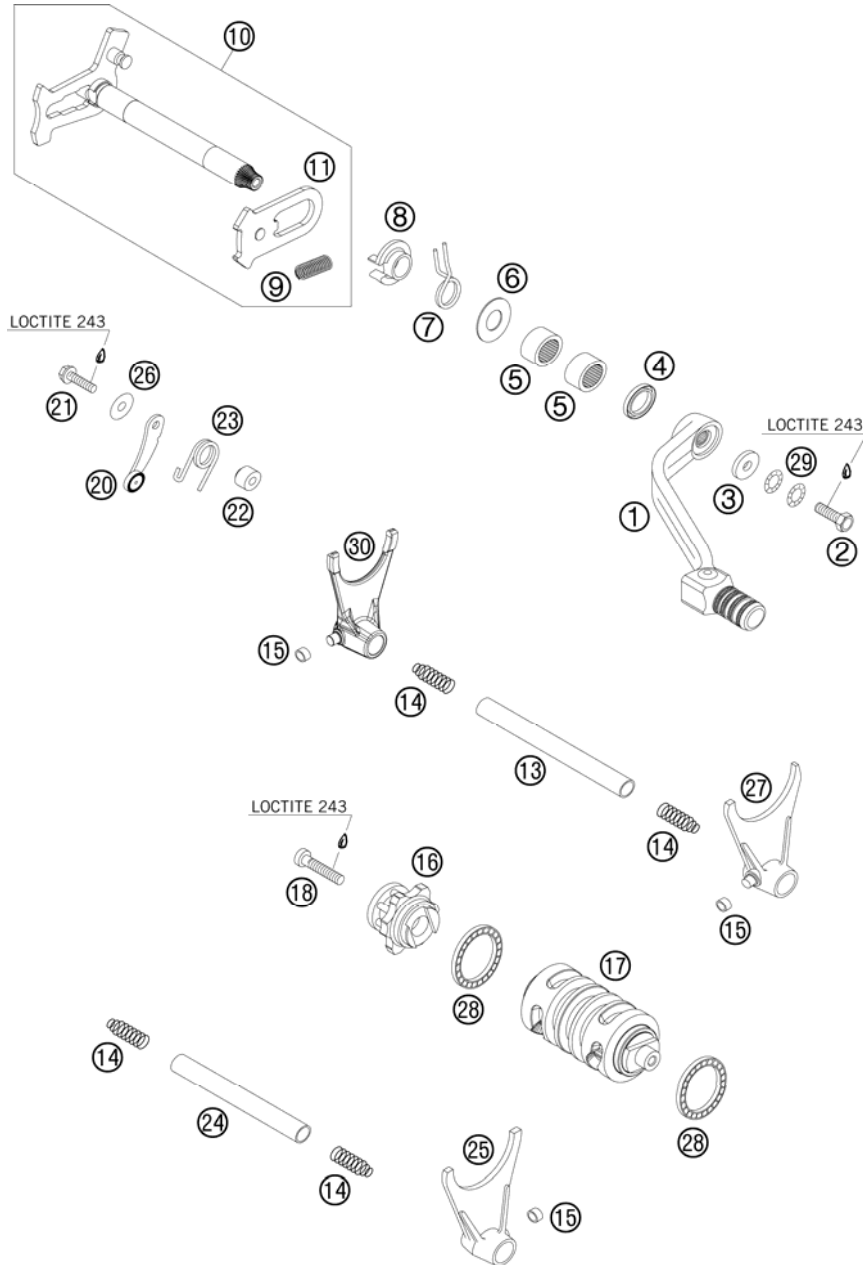

FIG	PART NUMBER	DESCRIPTION	QTY
1	59034031000	SHIFT LEVER CPL.RACING 2000	1
2	59009062016	SPECIAL SCREW M6X16 WS=8 10.9	1
3	50232050001	STEEL WASHER 6,4X17X3	1
4	0760142460	SHAFT SEAL RING 14X24X6 B	1
5	54632095000	NEEDLE BEAR.HK 1412 14X20X12	2
6	54634050000	STOP DISK 14X30X1	1
7	54634014100	RETURN SPRING 2,2MM '95	1
8	54634020000	SPRING GUIDE	1
9	56534013100	TENSIONING SPRING 0,8MM	1
10	78034005044	SHIFT SHAFT CPL.	1
11	54634008044	SLIDING PLATE CPL.	1
13	78034020000	SHIFT RAIL 11,8X101,5	1
14	58038023200	PRESSURE SPRING 0,9MM	4
15	50334018100	SHIFTING ROLLER 6X8X5,2	3
16	78034015144	SHIFT DRUM LOCATING ALU CPL.	1
17	78034012000	SHIFT ROLLER	1
18	0012060303	AH SCREW DIN6912 M6X30 8.8	1
20	77034024044	LOCKING LEVER CPL. 08	1
21	0025050206	HH COLLAR SCREW M5X20 TX30	1
22	54634052300	SLEEVE FOR LOCKING LEVER	1
23	60034023000	ARRESTING LEVER SPRING 03	1
24	78034019000	SHIFT RAIL 11,8X85	1
25	59034001000	SHIFT FORK 5./6.GEAR 2000	1
26	0349000050	WASHER DIN7349-5X15X2	1
27	59034002000	SHIFT FORK 2./4.GEAR 2000	1
28	0625618050	BALL BEARING 61805 C3	2
29	50233041000	PAIR OF WASHERS M 6 NORDLOCK	1
30	78034003000	SHIFTING FORK 1ST/3RD GEAR	1

087803410 / C097803410

* NEW PART

X AS REQUIRED

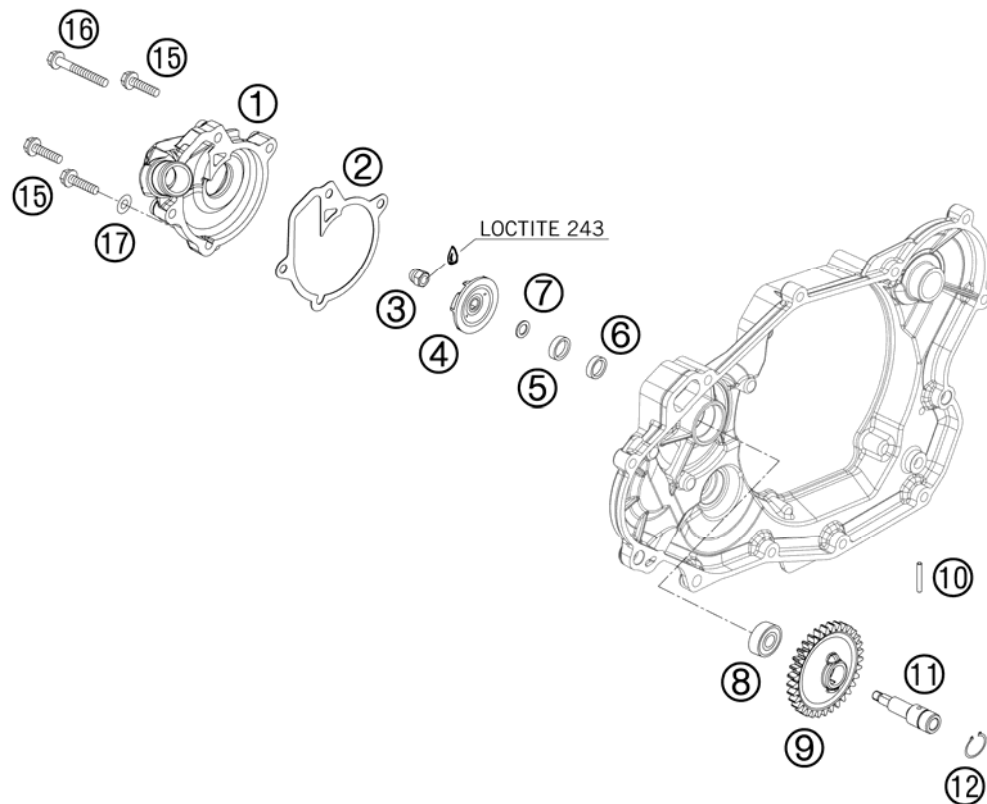

FIG	PART NUMBER	DESCRIPTION	QTY
1*	7803505200015	WATER PUMP COVER GREY	1
2	78035053000	GASKET WAPU-COVER 08	1
3*	0587060002	HH CAP NUT DIN1587-M 6 SS.	1
4	77335055100	WATER-PUMP WHEEL 07	1
5	0760102455	SHAFT SEAL RING 10X24X5,5	1
6	0760102440	SHAFT SEAL RING 10X24X4	1
7	78035054110	SPACER SHIM	1
8	0625060001	BALL BEARING 6000/C3	1
9	78035054001	DRIVE WHEEL WAPU PLASTIC MAT.	1
10	0402032180	NEEDLE ROLLER DIN5402 3X21,8	1
11	78035054100	WATER PUMP SHAFT	1
12	0471140100	LOCK WASHER DINO471-14X1	1
15	0025060256	HH COLLAR SCREW M6X25 TX30	3
16	0025060556	HH COLLAR SCREW M6X55 TX30	1
17	0603061001	CU-SEAL RING DIN7603-6X10X1	1

087803510 / C097803510

* NEW PART

X AS REQUIRED

COOLING SYSTEM

530 EXC USA 2009

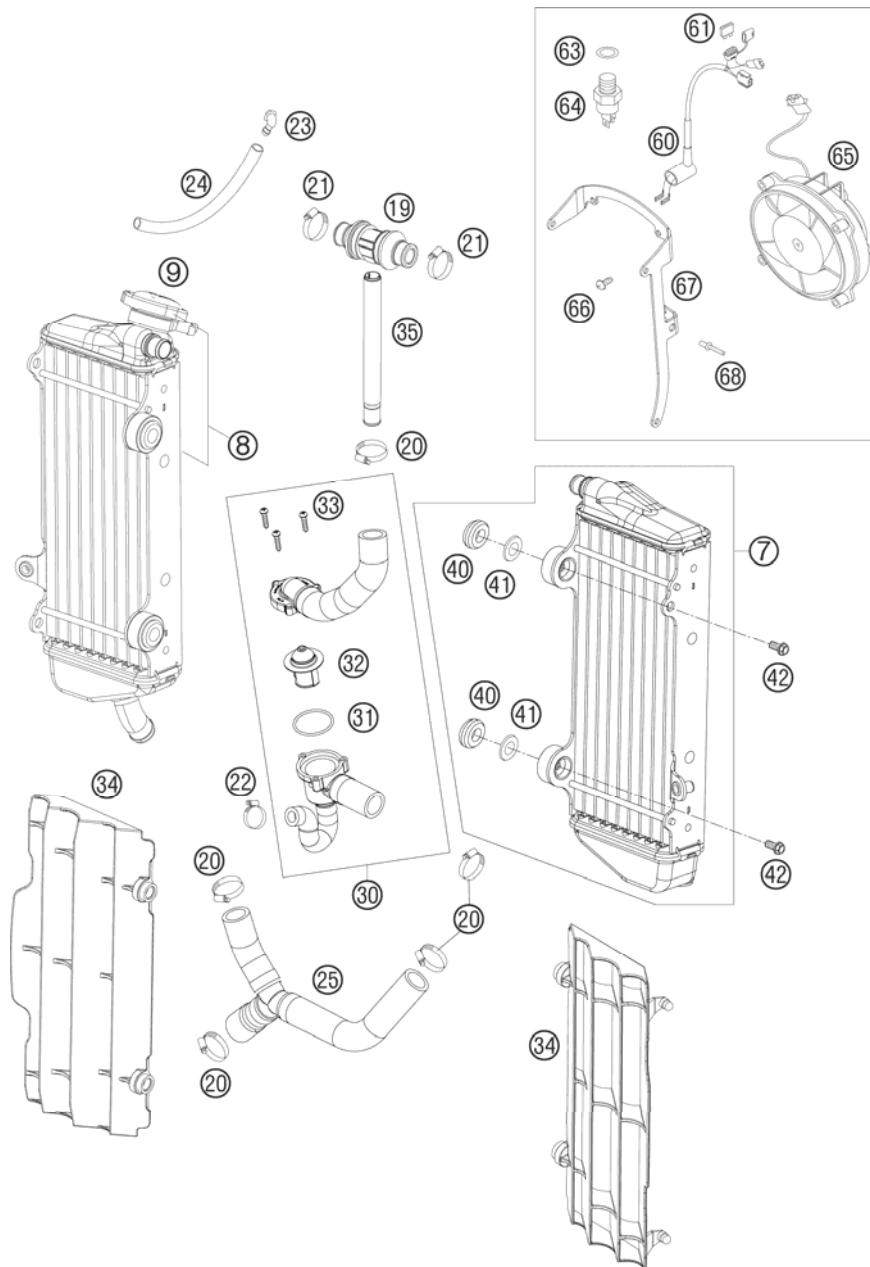

FIG	PART NUMBER	DESCRIPTION	QTY
7	77035007100	RADIATOR L/S 250 SX-F	07
8	78035008000	RADIATOR R/S "45556"	08
9	77335016000	RADIATOR CAP SMALL 1,8 BAR	1
19	77335026000	T-CONNECTOR CPL.	'07
20	10001020000	HOSE CLAMP GEMI 16-27	5
21	42013037300	HOSE CLAMP NORMA 12/22	2
22	58335099000	HOSE CLAMP GEMI 10-16	1
23	50303089000	ANGEL PIECE	'97
24	31007107001	PVC-HOSE 6X9 MM PER METER	x
25	78035027033	RADIATOR H. CPL. W. Y-PART	08
30	78035026033	RADIATOR H. CPL. W.THERM.75	08
31	0770320020	O-RING 32,00X2,00	1
32	59435017000	THERMOSTAT 70 DEGREE	04
33	0016040183	SCREW FOR PLASTIC D=4X18	3
34	7733503400030	RAD. PR. L/S+R/S BLACK SX	07
35	77335073000	HOSE CONNECTOR 4 STROKE	07
40	41001052000	RUBBER SLEEVE D=12MM	4
41	77335001000	WASHER FOR RADIATOR	08
42	0023060123	COLLAR SCREW M6X12	TX
60	59011079000	FAN WIRING HARNESS	2001
61	58011109105	FUSE 5 A	2003
63	0603142015	ALU SEALRING DIN7603-14X20X1,5	1
64	78035045000	THERMOSWITCH 95-100 DG	1
65	58435041000	FAN CPL. 12V LC4	2000
66	0081500181	SCREW FOR PLASTIC D=5X18	3
67	78035043000	FAN SUPPORT EXC	08
68	0011400800	RIVET 4,0X 8 ALU	3

097803530 / C097803530

* NEW PART

X AS REQUIRED

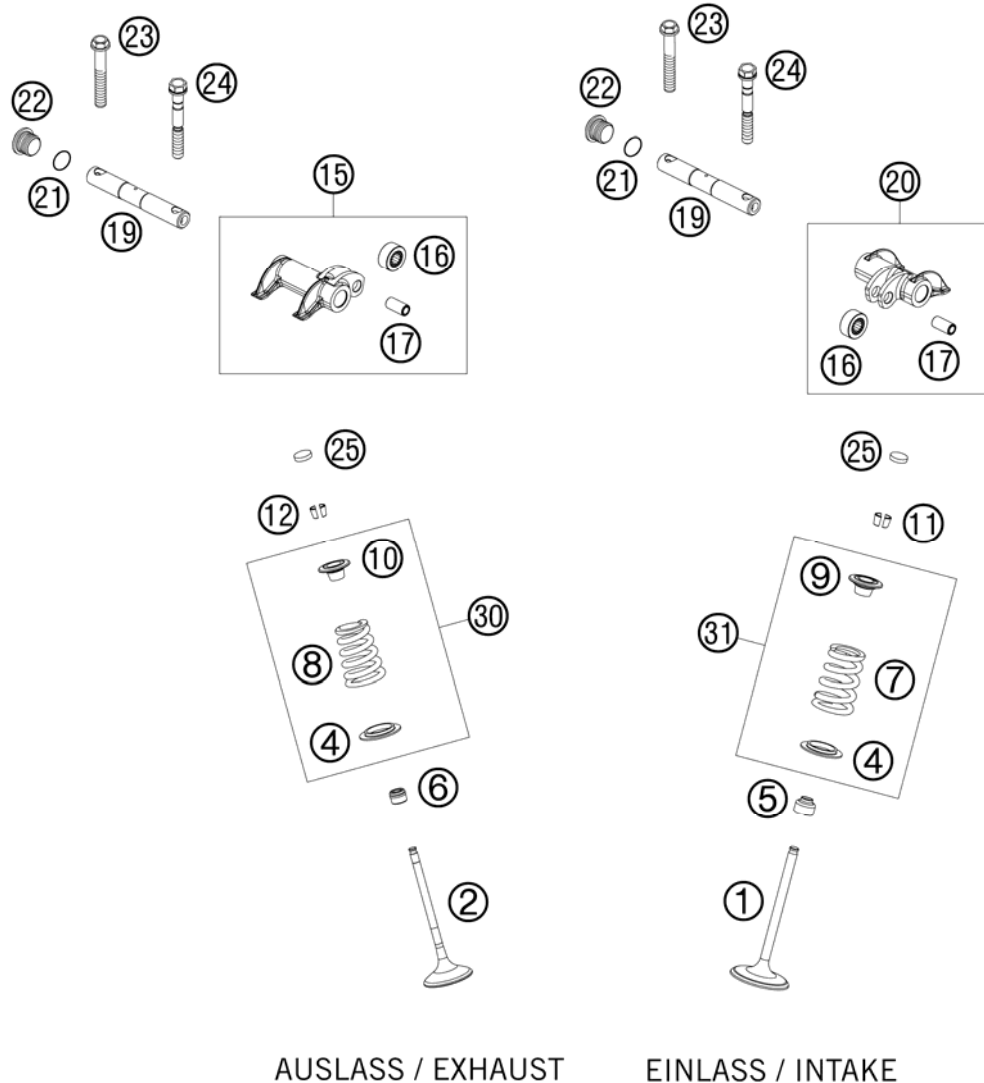

FIG	PART NUMBER	DESCRIPTION	QTY
1	78036030000	INTAKE VALVE	2
2	78036031000	EXHAUST VALVE	2
4	78036136000	VALVE SPRING HOLDER EXHAUST	4
5	59036027000	VALVE-STEM SEALING RACING	2
6	77036027000	VALVE-STEM SEALING 05	2
7	78036028000	VALVE SPRING INTAKE	2
8	78036029000	VALVE SPRING EXHAUST	2
9*	78036132100	VALVE SPRING RETAINER INTAKE	2
10*	78036032100	VALVE SPRING RETAINER EXHAUST	2
11	78036033000	VALVE COLLET LK 6H	4
12	77036033000	VALVE COLLET 05	4
15	78036061044	ROCKER ARM EXHAUST CPL.	1
16	59036061091	ROCKER ARM ROLLER	2
17	78036061092	BEARING BOLT ROCKER ARM ROLLER	2
19	78036056000	ROCKER ARM SHAFT	2
20	78036060044	ROCKER ARM INTAKE CPL.	1
21	0770110015	O-RING 1,5x11 SILICON	2
22	78036081000	HOLDING BOLT M14X1,5	2
23	77036080000	SPECIAL SCREW M7X40 WS10	2
24	78036080000	FIT BOLT M7X1X55	2
25	60036035200	SHIM D=10/2,00	03
25	60036035205	SHIM D=10/2,05	03
25	60036035210	SHIM D=10/2,10	03
25	60036035215	SHIM D=10/2,15	03
25	60036035220	SHIM D=10/2,20	03
25	60036035225	SHIM D=10/2,25	03
25	60036035230	SHIM D=10/2,30	03
25	60036035235	SHIM D=10/2,35	03
25	60036035240	SHIM D=10/2,40	03
25	60036035245	SHIM D=10/2,45	03
25	60036035250	SHIM D=10/2,50	03
25	60036035255	SHIM D=10/2,55	03
25	60036035260	SHIM D=10/2,60	03
25	60036035265	SHIM D=10/2,65	03
25	60036035270	SHIM D=10/2,70	03
25	60036035275	SHIM D=10/2,75	03

087803610 / C097803610

* NEW PART

X AS REQUIRED

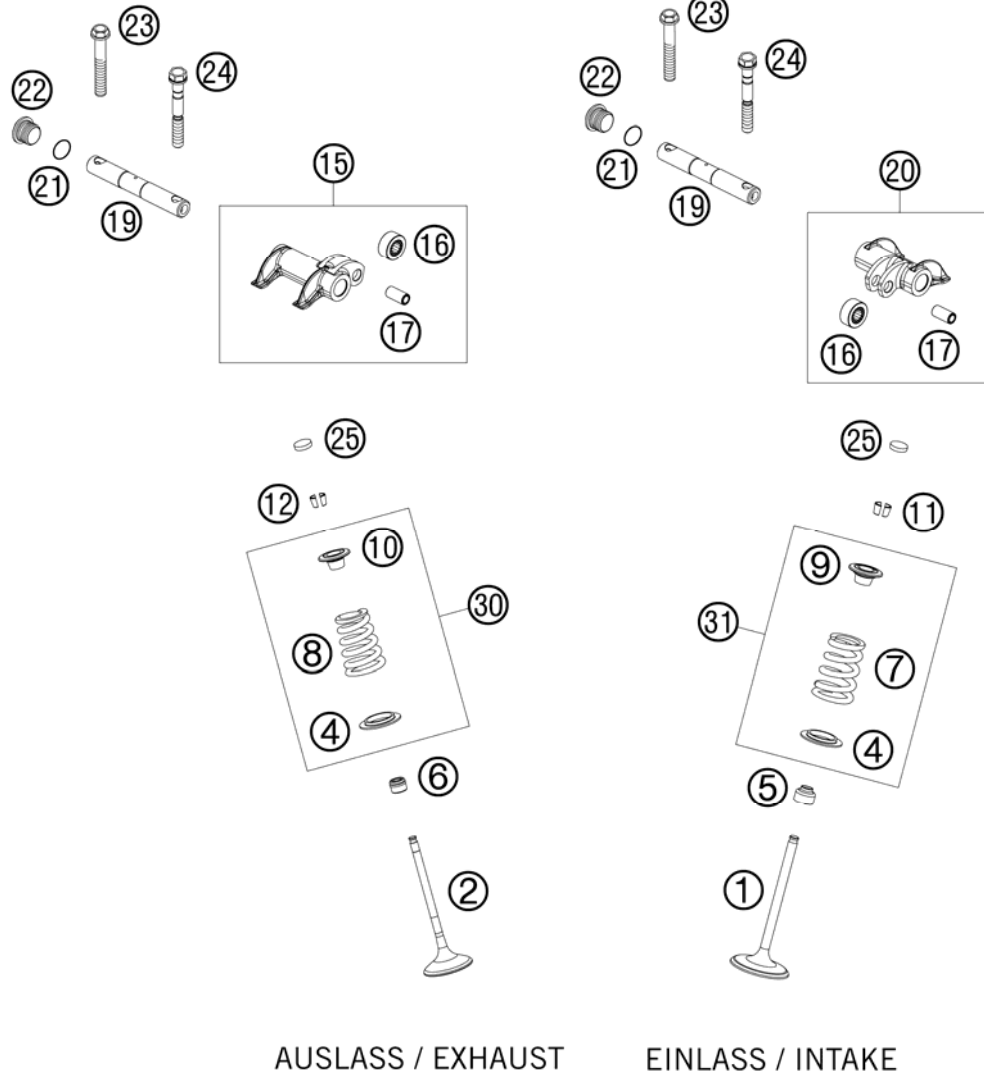

FIG	PART NUMBER	DESCRIPTION	QTY
25	60036035280	SHIM D=10/2,80	03
25	60036035285	SHIM D=10/2,85	03
25	60036035290	SHIM D=10/2,90	03
25	60036035295	SHIM D=10/2,95	03
25	60036035300	SHIM D=10/3,00	03
25	60036035305	SHIM D=10/3,05	03
25	60036035310	SHIM D=10/3,10	03
25	60036035315	SHIM D=10/3,15	03
25	60036035320	SHIM D=10/3,20	03
30*	78036029144	VALVE SPR.-KIT EX. 450-503	09
31*	78036028144	VALVE SPR.-KIT INT. 450-530	09

087803610 / C097803610

* NEW PART

X AS REQUIRED

TIMING DRIVE

530 EXC USA 2009

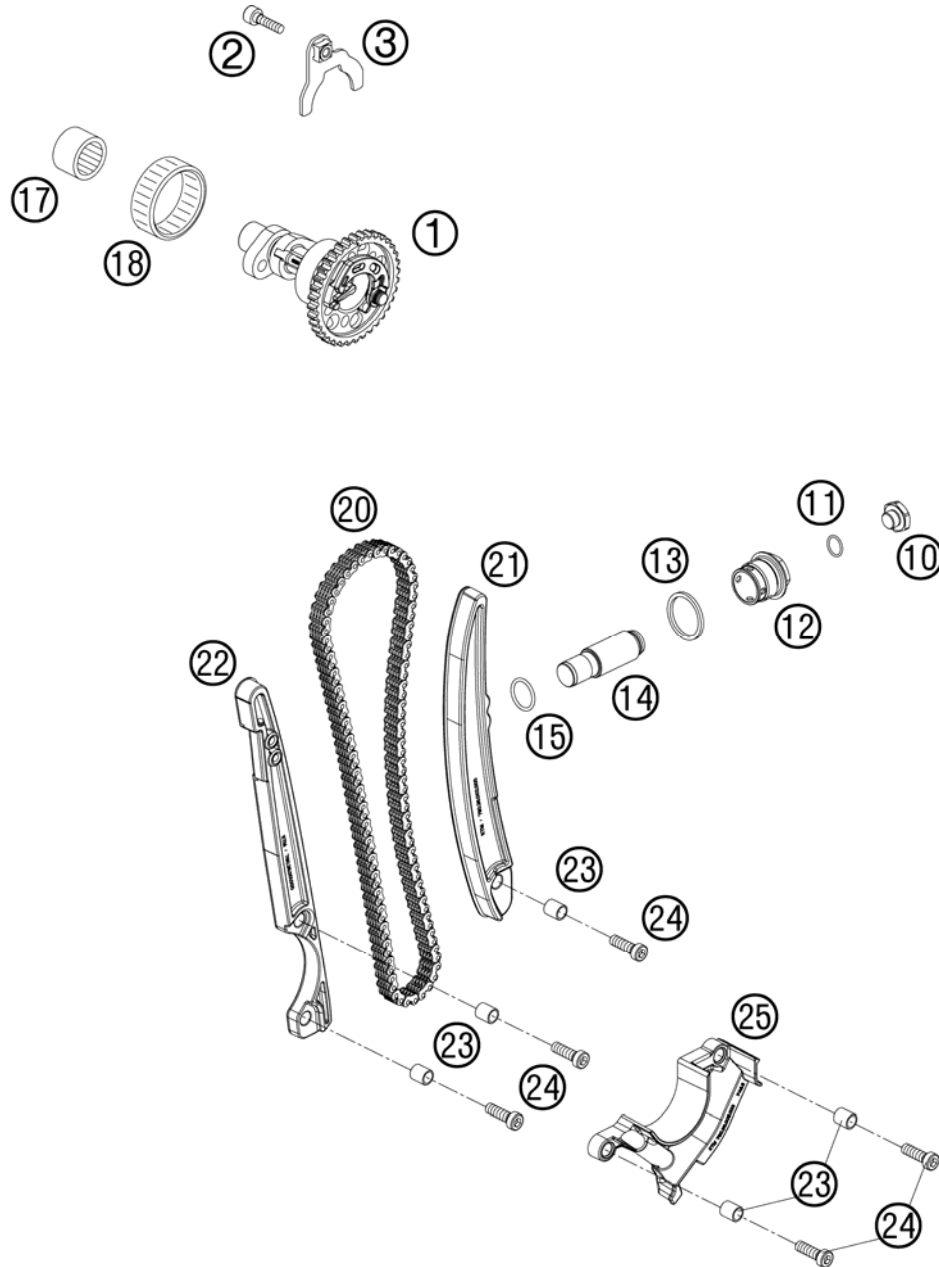

FIG	PART NUMBER	DESCRIPTION	QTY
1*	78636010033	CAMSHAFT W. AUTODECO	1
2	0912060208	AH SCREW DIN0912-M 6X20 SS	1
3	78036012033	RETAINING PLATE CAMSHAFT CPL.	1
10	77336008010	HOLDING BOLT	1
11	0770010010	O-RING 10,00X1,00 NBR 70 SH	1
12	78036008000	CHAIN ADJUSTER HOLDING BOLT	1
13	0603242920	CU SEAL-RING DIN7603 A24X29X2	1
14	77036003000	CHAIN ADJUSTER HYD. 05	1
15	0770180020	O-RING 18,00X2,00 NBR 70	1
17	0618182414	NEEDLE SLEEVE HK1814RS18/24/14	1
18	0618404712	NEEDLE SLEEVE HK4012B40X47X12	1
20	78636013000	TIMING CHAIN 114T 08	1
21	78036002000	TENSIONER RAIL	1
22	78036001000	GUIDE RAIL	1
23	77036001050	SPACER BUSHING 6.1X8.2X9.1 05	5
24	0984060203	AH SCREW DIN6912-M 6X20 8.8	5
25*	78036005100	FAILURE PROTECTION	1

097863620 / C097863620

* NEW PART

X AS REQUIRED

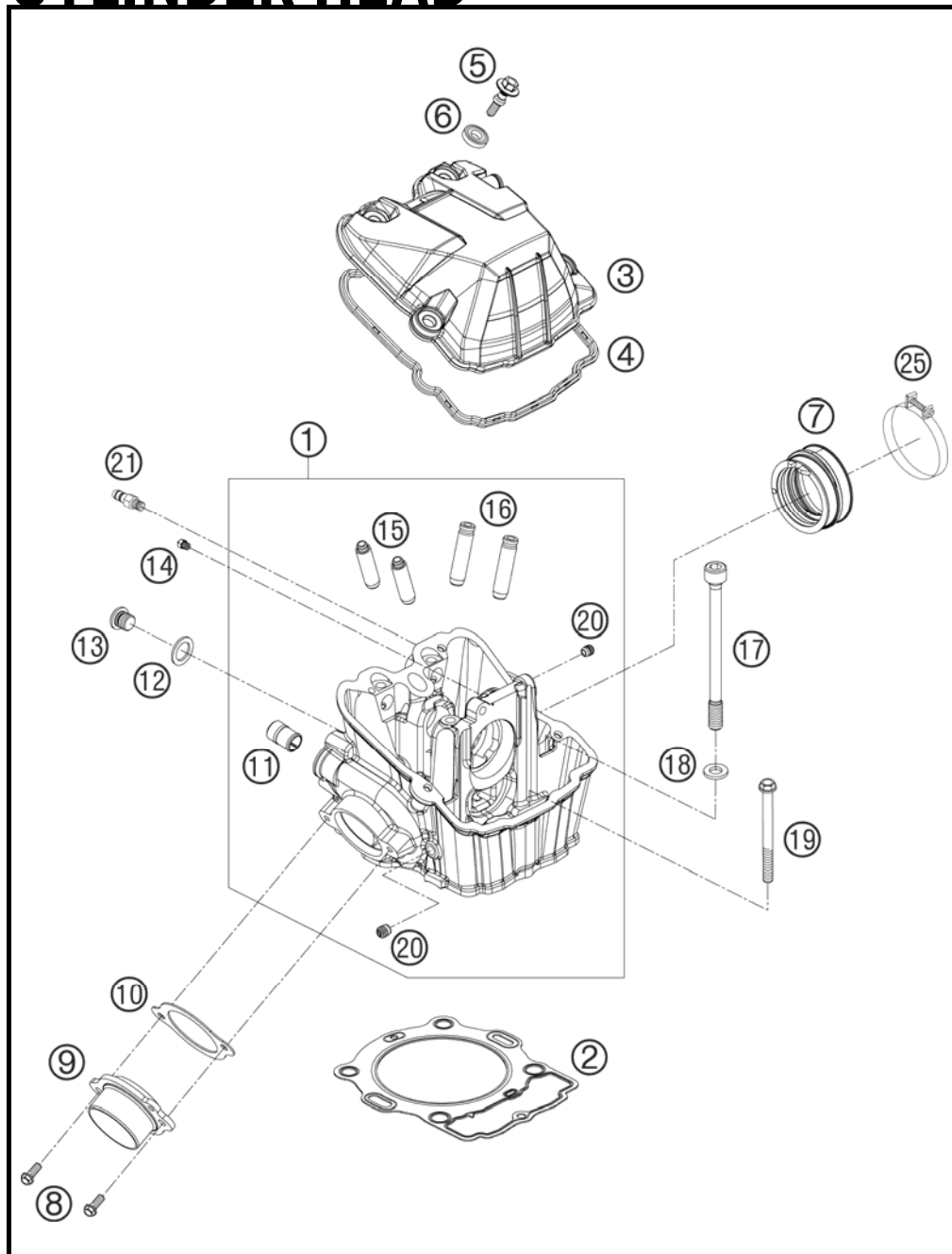

FIG	PART NUMBER	DESCRIPTION	QTY
1	78036020000	CYLINDER HEAD CPL. 08	1
2	78030036000	CYLINDER HEAD GASKET 08	1
3	7803605200033	VALVE COVER BLACK MATT	1
4	78036053000	VALVE COVER GASKET	1
5	78036054000	VALVE COVER SCREW	4
6	75036052010	DECOUPLING ELEMENT 07	4
7*	78036144100	INTAKE BOOT	1
8	0015060163	HH COLLAR SCREW M 6X16 WS=8	2
9*	78036139000	EXHAUST FLANGE CPL. EXC-F 08	1
10	78036041000	EXHAUST FLANGE GASKET	1
11	58030010200	SCREW IN NOZZLE M20X1,5	1
12	58038022000	CU-SEAL RING DIN7603-12X18X1,5	1
13	78036024000	PLUG SCREW SAS M12X1,5	1
14	60030063070	OIL JET 70 M5	1
15	78036026000	VALVE GUIDE EXHAUST	2
16	78036025000	VALVE GUIDE INTAKE	2
17	78630044000	CYL. HEAD SCREW M10X1,25 L=138	4
18	77336089010	WASHER 19X10,5X2,5	4
19	0025060856	HH COLLAR SCREW M6X85 TX30	1
20	59030296000	SCREW PLUG	2
21	58336020190	VACUUM CONECTION M6/3MM '97	1
25	59030061000	CLAMP D=56MM B=9MM M4X25	1

087803631 / C097863631

* NEW PART

X AS REQUIRED

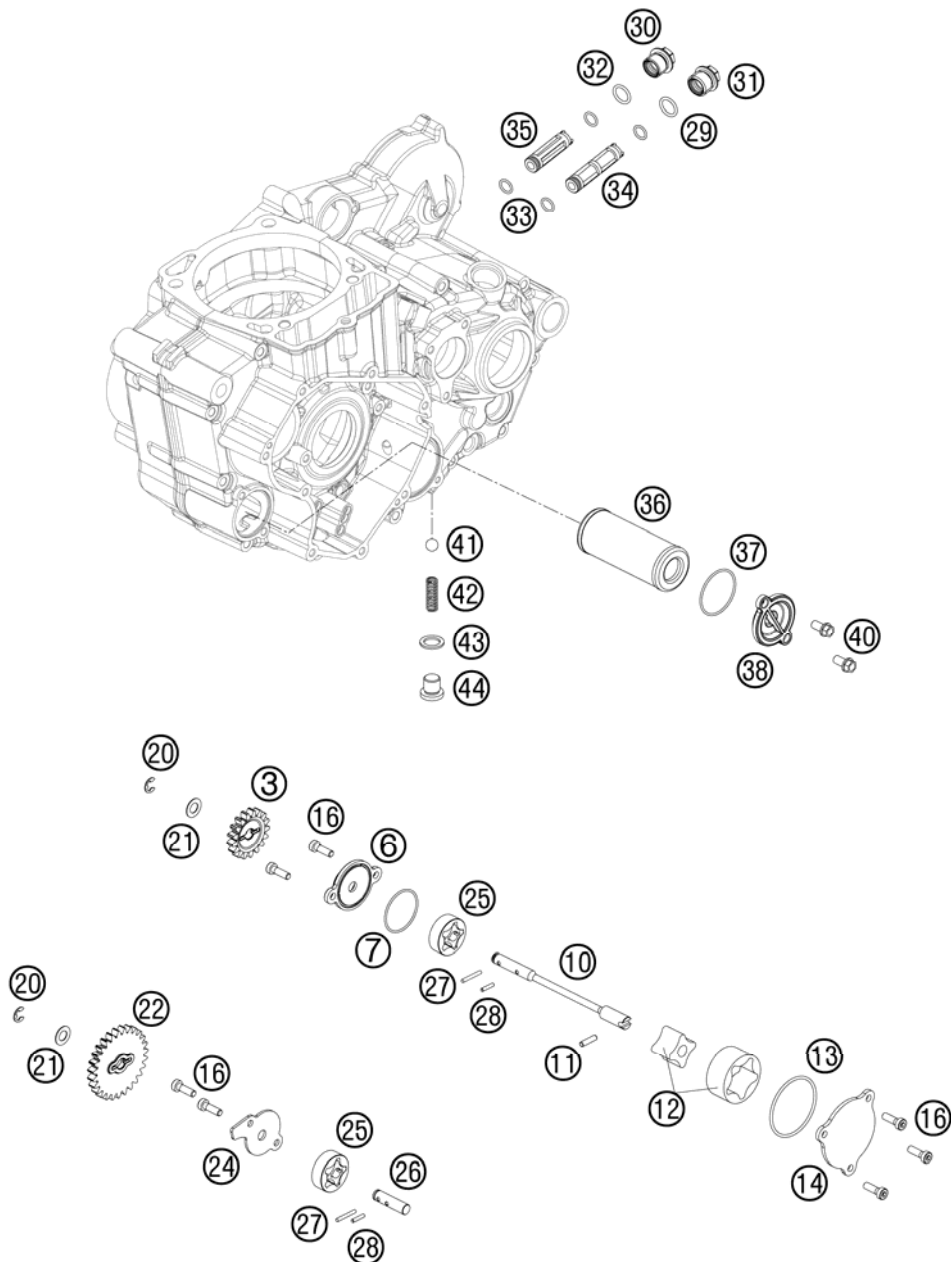

FIG	PART NUMBER	DESCRIPTION	QTY
3	78038001017	OIL PUMP GEAR 17 T	1
6	78038103233	OIL PUMP COVER CPL.	1
7	0770327013	O-RING 32,7X1,3 VITON 75SHORE	1
10	78038102000	OIL PUMP SHAFT SP-PP	1
11	0402041580	NEEDLE ROLLER NRB 4X15,8 G2	1
12	60038009000	ROTOR-SET 19MM 03	1
13	0770440020	O-RING 44,00X2,00 VITON	1
14	78038004000	OIL PUMP COVER SUCTION PUMP	1
16*	0984050163S	CYL. SCREW DIN6912 M5X16 8.8	7
20	0799060000	TAB WASHER DIN6799-RS 6,0	2
21	58038007755	STOP DISK 8,1 X 15 X 0,5	2
22	78038001027	OIL PUMP GEAR 27T	1
24	78038003000	OIL PUMP COVER TRANSM. PUMP	1
25	59038011010	OILPUMP ROTOR CPL. 10MM G-73R	2
26	78038002000	OIL PUMP SHAFT TRANSM. PUMP	1
27	0402251980	NEEDLEROL.DIN5402 NRA 2,5X19,8	2
28	0402251180	NEEDLE ROLLER DIN5402 2,5X11,8	2
29	0770125020	O-RING 12,50X2,00 NBR 70	1
30	78038017000	SCREW PLUG M16	1
31	78038018000	SCREW PLUG M17	1
32	0770120020	O-RING 12,00X2,00 NBR 70	1
33	0770090015	O-RING 9X1,5 NBR	4
34	78038015000	OIL SCREEN 12,5X56,5MM	1
35	59038015100	OIL SCREEN 11,8x44,5MM	1
36	77338005100	OIL FILTER	1
37*	07703305178	O-RING 33,05X1,78	1
38*	77338041200	OIL FILTER COVER 08	1
40	0025060166	HH COLLAR SCREW M6X16 TX30	2
41	0401090003	BALL DIN5401-9	1
42	58038023300	PRESSURE SPRING L=25MM D=1MM	1
43	58038022000	CU-SEAL RING DIN7603-12X18X1,5	1
44	0908120153	PLUG DIN0908-M12X1,5	1

097803810 / C097803810

* NEW PART

X AS REQUIRED

IGNITION SYSTEM

530 EXC USA 2009

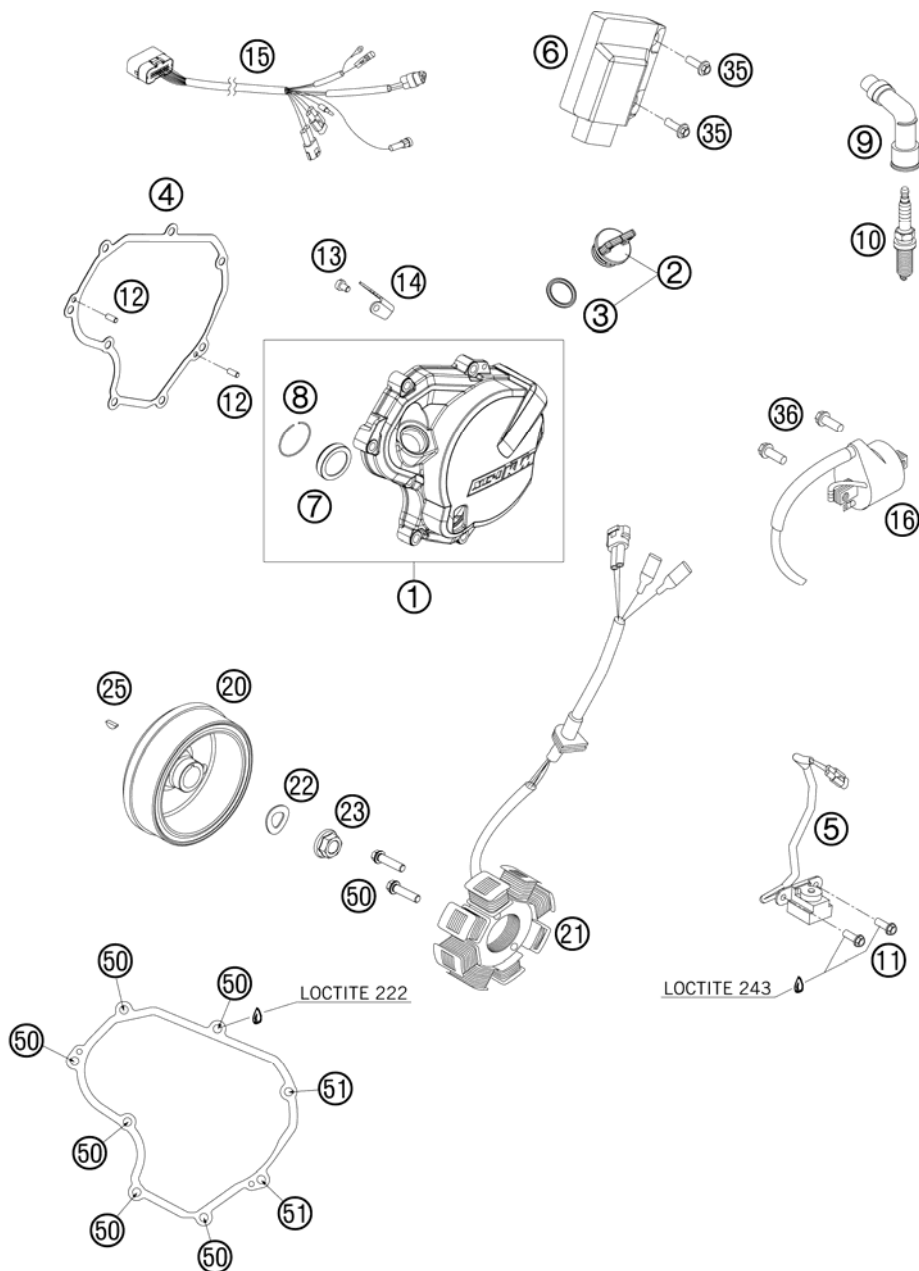

FIG	PART NUMBER	DESCRIPTION	QTY
1*	7803000210015	IGNITION COVER EXC	1
2	58030020100	PLUG CPL. M24X3	1
3	0770191015	O-RING 19,00X3,00 NBR	1
4	78030040000	GASKET IGNITION COVER 08	1
5	77339034000	PULSER COIL KOKUSAN "PU5165"	1
6*	78639031300	CDI UNIT 530 EXC USA 09	1
7	78030095000	OIL LEVEL GLASS 30X8 07	1
8	61030019050	CIRCLIP OIL LEVEL GLASS 03	1
9	78039090000	SPARK PLUG CONNECT. AP-TRS1908	1
10*	75039093000	SPARK PLUG M12X1,25 LKAR8AI-9	1
11	0025050166	HH COLLAR SCREW M5X16 TX30	2
12	0402040980	NEEDLE ROL.DIN5402 NRB 4X9,8	2
13*	0019040106S	FLAT HEAD SCREW ISA25 M4X10	1
14	78030002010	WIRING RETAINING BRACKET	1
15	78039032000	WIRING HARNESS F. CDI-BOX 08	1
16	59039006000	IGNITIONCOIL KOKUSAN 4K3-A/B	1
20	78039005000	FLYWHEEL	1
21	80039004000	STATOR HUSABERG FS/FE 04	1
22	0137120000	SPRING WASHER DIN0137-B12	1
23	49030021000	COLLAR NUT M12X1 R/S	1
25	0888030050	WOODRUFF KEY DIN6888-3X5X13	1
35	0023060123	COLLAR SCREW M6X12 TX	2
36	0025060166	HH COLLAR SCREW M6X16 TX30	1
37	0025060206	HH COLLAR SCREW M6X20 TX30	1
50	0025060256	HH COLLAR SCREW M6X25 TX30	8
51	0025060406	HH COLLAR SCREW M6X40 TX30	2

087803910 / C097863911

* NEW PART

X AS REQUIRED

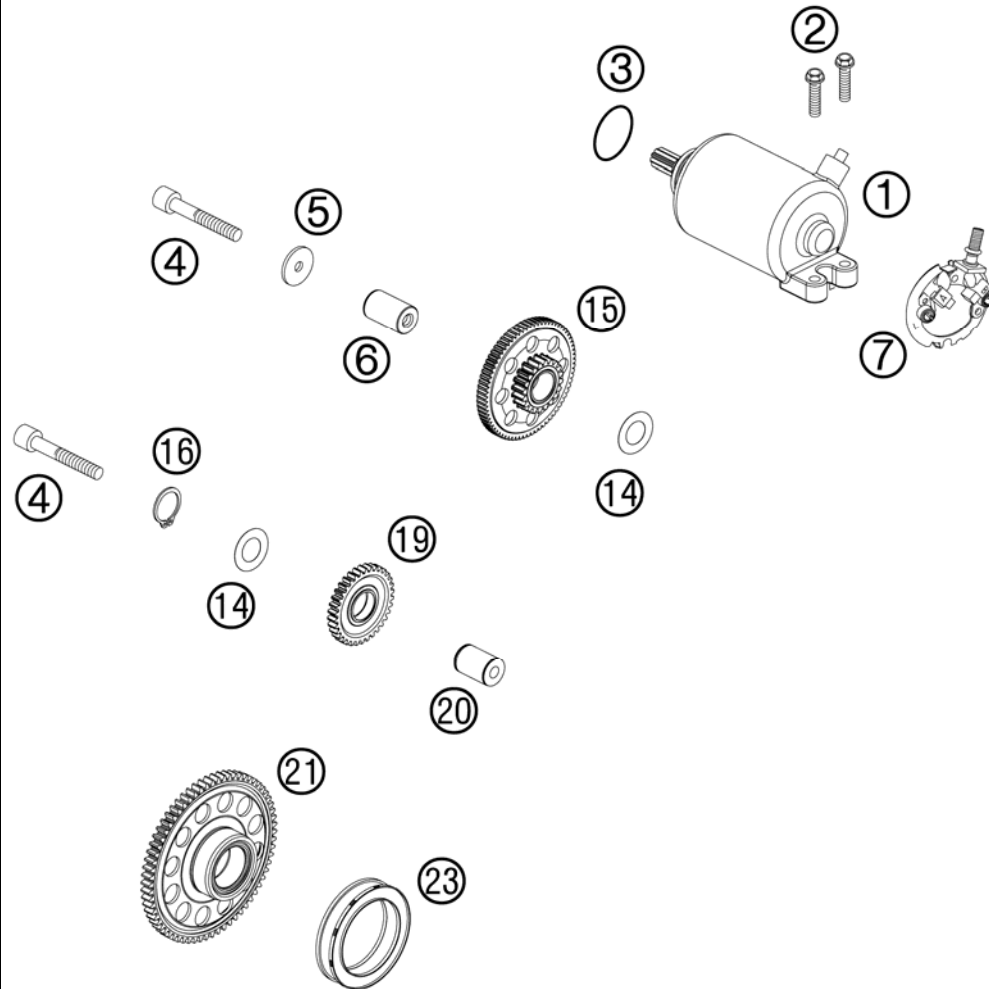
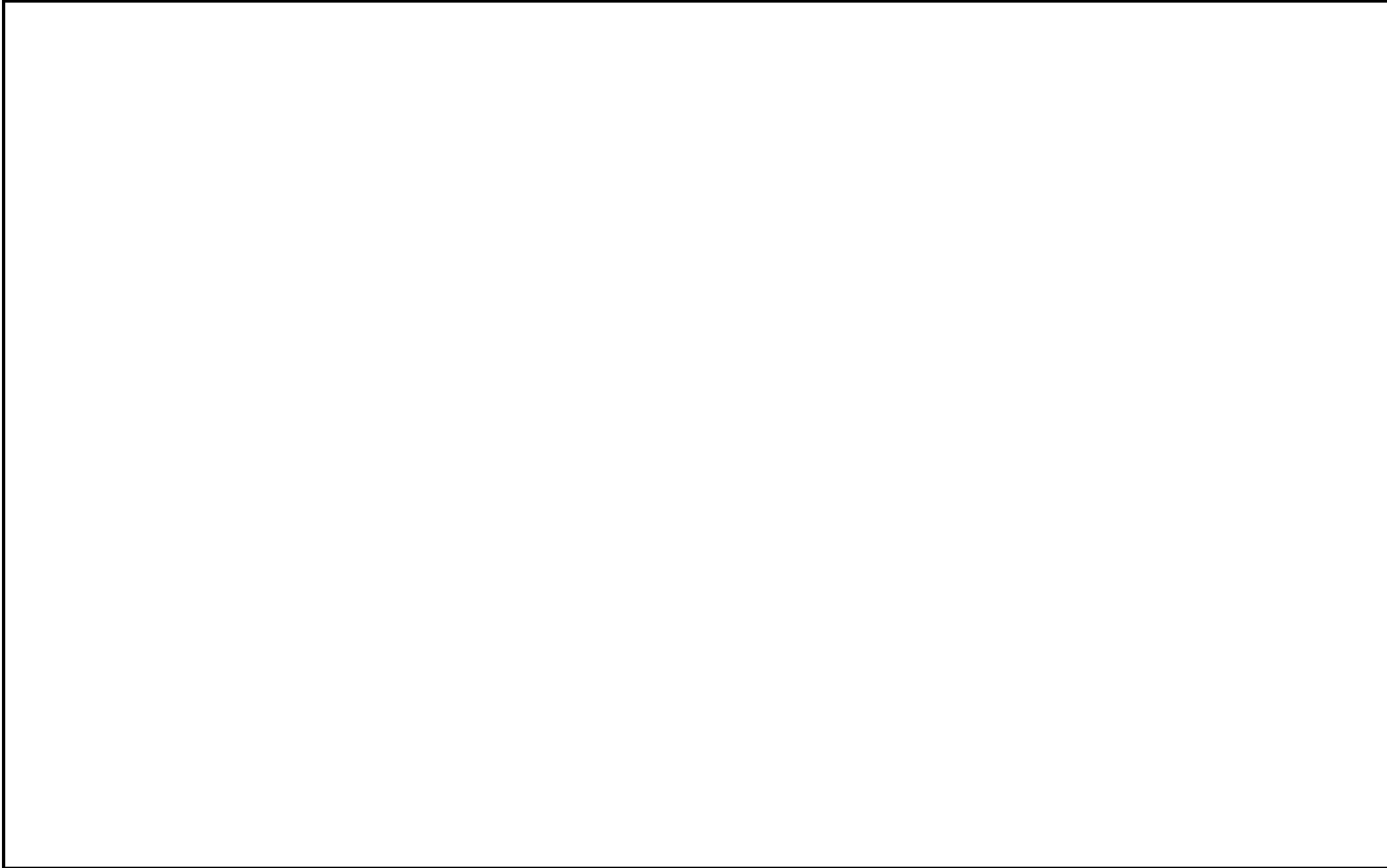

FIG	PART NUMBER	DESCRIPTION	QTY
1	78040001000	E-START. ENGINE CPL. 0,45KW 08	1
2	0025060206	HH COLLAR SCREW M6X20 TX30	2
3	0770020220	O-RING 25,12X1,78 NBR70	1
4	0912060404	AH SCREW DIN0912-M 6X40 A2	2
5	78040016004	STOP DISC 6X23X2	1
6	78040029000	BEARING BOLT	1
7	78040002000	BRUSH HOLDER F. STARTER	1
14	0988172405	SHIM WASHER DIN0988-17X24X0,5	2
15	78040016000	TORQUE LIMITER CPL.	1
16	0471170010	CIRCLIP DIN0471-17X1	1
19	78040022000	IDLER GEAR 30-T CPL.	1
20	78040028000	BUSHING PIN	1
21*	78040020133	FREEWHEEL GEAR CPL.	1
23*	75040026000	FREE WHEEL	1

097804010 / C097804010

* NEW PART

X AS REQUIRED







KTM-Sportmotorcycle AG
A-5230 Mattighofen
www.ktm.at

KTM Group Partner



3CM089625IEN



Art.Nr.: 3CM089625IEN 6/2008